

SADY®



Catalogue



2023

Hand Tools



SADY®

hand tools



HAND TOOLS



METALLIC BLOWTORCH - HURRICANE



Burner: Ø 20 mm
Consumption: 111 g./h
Power: 2,1 kW



Code	Ref.		EAN
5110153	100P	w/lighter	6934589405526

PLASTIC BLOWTORCH - TYPHOON

Burner: Ø 28 mm
Consumption: 127 g./h
Power: 1,76 kW



Code	Ref.		EAN
5104940	120P	w/lighter	6934589405618

METALLIC BLOWTORCH - TYPHOON

Burner: Ø 20 mm
Consumption: 127 g./h
Power: 1,76 kW



Code	Ref.		EAN
5105270	100P	w/lighter	6934589405519

PLASTIC BLOWTORCH - TYPHOON

Burner: Ø 28 mm
Consumption: 127 g./h
Power: 1,76 kW



Code	Ref.		EAN
5104939	120	w/o lighter	6934589405601

METALLIC BLOWTORCH - TYPHOON

Burner: Ø 20 mm
Consumption: 127 g./h
Power: 1,76 kW



Code	Ref.		EAN
5105271	100	w/o lighter	6934589405502

BUTANE GAS (ILL)



Code	Ref.		EAN
5511050	190 g cartridge	36	5602482042278

GAS TORCH WITH 3 BURNERS



Code	Ref.	burners consumption		EAN
5106021	I008L	Ø 25 mm 250 g/h Ø 35 mm 450 g/h Ø 50 mm 2.000 g/h	6	6934589410353

GAS TORCH



Consumption: 2.500 g/h
Power: 35 kW
Total length: 430 mm

Code	Ref.			EAN
5104969	I048L	Ø 60 mm	6	6934589411152

GAS TORCH



Consumption: 450 g/h
Power: 6.3 kW
Total length: 360 mm

Code	Ref.			EAN
5104935	I044L	Ø 35 mm	6	6934589410957

GAS TORCH



Consumption: 3.850 g/h
Power: 54 kW
Total length: 580 mm

Code	Ref.			EAN
5104937	I066L	Ø 76 mm	6	6934589411503

GAS TORCH



Consumption: 1.400 g/h
Power: 19,5 kW
Total length: 400 mm

Code	Ref.			EAN
5104936	I046L	Ø 45 mm	6	6934589411053

BURNERS FOR GAS TORCHES



Code	Ref.			EAN
5104941	I335	Ø 35 mm 450 g/l 6,3 kW	30	6934589414450
5104942	I336	Ø 45 mm 1.400 g/l 19,5 kW	60	6934589414467
5108462	I338	Ø 60 mm 2.500 g/l 35 kW	24	6934589414481
5104943	I339	Ø 76 mm 3.850 g/l 54 kW	24	6934589414498

GAS WELDING TORCH



Consumption: 140 g/h
Power: 1.4 kW
Total length: 310 mm

Code	Ref.		EAN
5104933	I001	17 mm	6934589410001

GAS WELDING TORCH PIN



Code	Ref.		EAN
5105507	I440	copper 200 g	6934589413804

GAS WELDING TORCH



Consumption: 140 g/h
Power: 2.1 kW
Total length: 410 mm
These torches are suitable for the welding of copper pipes.

Code	Ref.		EAN
5104934	I010L	Ø 22 mm	6934589410407

FLAT NOZZLE



Consumption: 140 g/h
Power: 2.8 kW

Code	Ref.		EAN
5105824	I325	Ø 40 mm	6934589413422

GAS BLOWTORCH



Consumption: 127 g/h
Power: 1.76 kW
1 rubber tubing (1 m) / 3 burners (Ø 20/24/40 mm), 1 welding nozzle

Code	Ref.		EAN
5118016	SET 2	w/o lighter	6934589405816

CAMPING GAS STOVE



Consumption: 97,5 g/h
Power: 1,3 kW

Code	Ref.		EAN
5105509	COOK100P w/lighter	6	6934589406417
5108704	COOK100 w/o lighter	6	6934589406400

METALIC LANTERN



Consumption: 82,5 g/h
Power: 1,1 kW

Code	Ref.		EAN
5105508	FLY100P w/lighter	6	6934589407414
5110476	FLY100 w/o lighter	6	6934589407407

CHROME PLATED GAS STOVE



Consumption: 78 g/h
Power: 1,35 kW

Code	Ref.		EAN
5106801	COOK200C campingas	6	6934589408022
5118166	COOK100F flaga	6	6934589408053

LAMP MANTLE



Code	Ref.		EAN
5108463	I310 100 W (3) (FLY 100/100P)	24	6934589413255
5108018	I312 500 W (3) (FLY 500C)	24	6934589413262

REPLACEMENT GLASS FOR LANTERNS



Code	Ref.		EAN
5105131	I300 Ø 81 mm (FLY 100/100P)	12	6934589413255
5108018	I312 Ø 120 mm (FLY 500C)		6934589413262

ENAMELLED GAS STOVE



Consumption: 69/98 g/h
 Power: 2,6 kW
Size:
 Height: 80 mm / Width: 480 mm
 Depth: 290 mm

Code	Ref.		EAN
5109248	MULTIFIRE2 2 burners		6934589409302

PROFESSIONAL GAS STOVE



Consumption: 544 g/h
 Power: 7,5 kW
Size:
 Height: 180 mm / Width: 390 mm
 Depth: 390 mm

Code	Ref.		EAN
5109247	POWERFIRE4		6934589409104

ENAMELLED GAS STOVE



Consumption: 47/69/98 g/h
 Power: 4,1 kW
Size:
 Height: 80 mm / Width: 560 mm
 Depth: 290 mm

Code	Ref.		EAN
5109249	MULTIFIRE3 3 burners		6934589409401

PUTTY KNIFE - BI-MATERIAL HANDLE



Code	Ref.		Code	EAN
5110486	2189SS	20 mm	12	5602482027688
5110487	2190SS	30 mm	12	5602482027695
5110492	2195SS	80 mm	12	5602482027749

GAUGING TROWEL - BI-MATERIAL HANDLE



Code	Ref.		Code	EAN
5118754	DS4191	6" 150 mm	12	5602482041912

PUTTY KNIFE - BI-MATERIAL HANDLE



Code	Ref.		Code	EAN
5114815	DS5008	25 mm	6	5602482050082
5114816	DS5009	40 mm	6	5602482050099
5114817	DS5010	50 mm	6	5602482050105
5114818	DS5011	65 mm	6	5602482050112
5114819	DS5012	75 mm	6	5602482050129
5114820	DS5013	100 mm	6	5602482050136
5114821	DS5014	125 mm	6	5602482050143

GAUGING TROWEL - BI-MATERIAL HANDLE



Code	Ref.		Code	EAN
5118751	DS5430	8" 200 mm	12	5602482054301
5118752	DS4192	8.1/2" 215 mm	12	5602482041929
5118753	DS5431	9" 230 mm	12	5602482054318

GAUGING TROWEL - BI-MATERIAL HANDLE



Code	Ref.		Code	EAN
5118747	DS4194	6" 150 mm	12	5602482054301
5118748	DS5432	8" 200 mm	12	5602482054325
5118749	DS5433	8.1/2" 215 mm	12	5602482054332
5118750	DS4196	9" 230 mm	12	5602482041967

WOOD CHISEL



Code	Ref.		Code	EAN
5109709	XS4022	6 mm	10	5602482014152
5109710	XS4022	8 mm	10	5602482014459
5109711	XS4022	10 mm	10	5602482014589
5109712	XS4022	12 mm	10	5602482014596
5109713	XS4022	15 mm	10	5602482014756
5109714	XS4022	18 mm	10	5602482014763
5109715	XS4022	20 mm	10	5602482014848
5109716	XS4022	22 mm	10	5602482015111
5106717	XS4022	25 mm	10	5602482015722
5109718	XS4022	28 mm	10	5602482016545
5109719	XS4022	30 mm	10	5602482016798
5109720	XS4022	35 mm	10	5602482016859
5109721	XS4022	38 mm	10	5602482017108

FLAT NOSE PLIERS



Code	Ref.		EAN
5101169	6" 150 mm	6	5602482023321

WIRE STRIPPER



Code	Ref.		EAN
5101189	6" 150 mm	6	5602482023437

HEAVY DUTY DIAGONAL PLIERS



Code	Ref.		EAN
5101171	6" 150 mm	6	5602482023345

LONG NOSE PLIERS



Code	Ref.		EAN
5101172	8" 200 mm	6	5602482023352

HEAVY DUTY DIAGONAL PLIERS



Code	Ref.		EAN
5101184	7" 180 mm	6	5602482023413
5101185	8" 200 mm	6	5602482023420

LONG NOSE PLIERS



Code	Ref.		EAN
5101173	6" 150 mm	6	5602482023369
5101174	8" 200 mm	6	5602482023376

FRONT CUTTING PLIERS



Code	Ref.		EAN
5101191	6" 150 mm	6	5602482023451
5101192	8" 200 mm	6	5602482023468

COMBINATION PLIERS



Code	Ref.		EAN
5101180	6" 150 mm	6	5602482023383
5101181	7" 180 mm	6	5602482023390
5101182	8" 200 mm	6	5602482023406

FLAT NOSE PLIERS



Code	Ref.		EAN
5106184	FNPF6	6" 150mm	5602482017832

WATER PUMP PLIERS



Code	Ref.		EAN
5101190	DS2344	10" 250 mm	5602482023444

FRONT CUTTING PLIERS



Code	Ref.		EAN
5106829	ENPF6	6" 150 mm	5602482017863
5106830	ENPF8	8" 200 mm	5602482017870

WATER PUMP PLIERS



Code	Ref.		EAN
5109644		10" 250 mm	5602482012691
5109645		12" 300 mm	5602482012752

LONG NOSE PLIERS



Code	Ref.		EAN
5106186	LNPF6	6" 150 mm	5602482017917
5106187	LNPF8	8" 200 mm	5602482017924

WIRE STRIPPER



Code	Ref.		EAN
5114758	DS4880	160 mm	5602482048805

INSULATED WATER PUMP PLIERS



Code	Ref.		EAN
5114571	D2GL250	10" 250 mm	5602482047242

ELECTRODE HOLDER



Code	Ref.		EAN
5102783		300 A	5602482026520
5102784		500 A	5602482026537

SELF GRIP PLIERS



Code	Ref.		EAN
5109639	5" 125 mm	6	5602482021839
5106913	7" 180 mm	6	5602482010543
5106914	10" 250 mm	6	5602482010550
5110547	12" 300 mm	6	5602482028456

FLAT WELDING LOCKING PLIERS



Code	Ref.	Medida Abertura		EAN
5114750	DS4872	8R 200 mm 78 mm		5602482048720

SELF GRIP PLIERS



Code	Ref.	Medida Abertura		EAN
5114747	DS4869	10CR 250 mm 48 mm		5602482048690

C TYPE WELDING LOCKING PLIERS



Code	Ref.	Medida Abertura		EAN
5114752	DS4874	11R 275 mm 102 mm		5602482048744

SELF GRIP PLIERS



Code	Ref.	Medida Abertura		EAN
5114748	DS4870	7R 175 mm 38 mm		5602482048706
5114749	DS4871	10R 250 mm 48 mm		5602482048713

C TYPE WELDING LOCKING PLIERS WITH SWIVEL PAD



Code	Ref.	Medida Abertura		EAN
5114751	DS4873	11SP 275 mm 102 mm		5602482048737

RIVETER



For rivets: 2.4 mm / 3.2 mm / 4.0 mm / 4.8 mm

Code	Ref.		EAN
5104497	DPM0063	300 mm 	6 5602482000063

LONG HANDLE RIVETER



For rivets: 2.4 mm / 3.2 mm / 4.0 mm / 4.8 mm / 6.4 mm

Code	Ref.		EAN
5114578	DS-4723	400 mm 	20 5602482047235

RIVETER



Code	Ref.		EAN
5114579	DS-4721	260 mm 	10 5602482047211

LAZY TONGUE RIVETER



For rivets: 2.4 mm / 3.2 mm / 4.0 mm / 4.8 mm / 6.4 mm

Code	Ref.		EAN
5114576	DS-4722	300 mm 800 mm 	12 5602482047228

RIVETER



For rivets: 2.4 mm / 3.2 mm / 4.0 mm / 4.8 mm

Code	Ref.		EAN
5114577	DS-4720	260 mm 	6 5602482047204

DIAGONAL CUTTING PLIERS



Code	Ref.		EAN
5106608	WD-01	8" 200 mm 	6 5602482008489

FLAT NOSE PLIERS (MINI)



Code	Ref.		EAN
5108839	CB1341 150 mm	6	5602482013414

BENT LONG NOSE PLIERS (MINI)



Code	Ref.		EAN
5101168	CB2328 150 mm	6	5602482023284

FRONT CUTTING PLIERS (MINI)



Code	Ref.		EAN
5108841	CB1340 150 mm	6	5602482013407

WATER PUMP PLIERS SWEDISH TYPE 45°



Code	Ref.		EAN
5106622	1" 25 mm	6	5602482021693
5106623	1.1/2" 38 mm	4	5602482021709
5106624	2" 50 mm	2	5602482021716

WATER PUMP PLIERS SWEDISH TYPE 90°



Code	Ref.		EAN
5106619	1" 25 mm	6	5602482021723
5106620	1.1/2" 38 mm	4	5602482021730
5106621	2" 50 mm	2	5602482021747

ADJUSTABLE WRENCH



Code	Ref.		EAN
5106614	6" 152 mm	6	5602482009424
5106615	8" 200 mm	6	5602482013612
5106616	10" 255 mm	6	5602482013629
5106617	12" 300 mm	6	5602482013636
5106618	15" 380 mm	2	5602482013643
5109301	18" 460 mm	1	5602482010567
5114383	24" 600 mm	1	5602482046757

CROSS WRENCH (GALVANISED)



Code	Ref.		EAN
5108439	13 / 17 / 19 / 21 mm	20	5602482005754

STILLSON TYPE PIPE WRENCH (ALUMINIUM)



Code	Ref.		EAN
5110734	10" 255 mm	6	5602482030473
5110735	12" 300 mm	6	5602482030480
5106921	14" 355 mm	6	5602482021808
5106922	18" 460mm	12	5602482021815
5106923	24" 609 mm	6	5602482021822
5109859	36" 915 mm	4	5602482029330
5114384	48" 1.220 mm	1	5602482046764

STILLSON TYPE PIPE WRENCH (RIDGID)

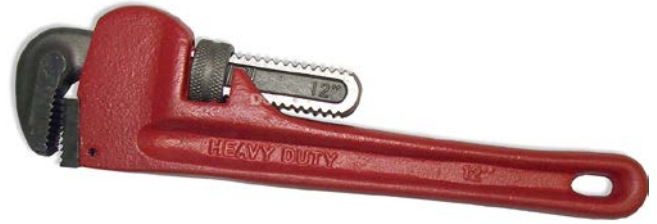

Code	Ref.		EAN
5109565	8" 152 mm		5602482029347
5106915	10" 255 mm	30	5602482004009
5106916	12" 300 mm	24	5602482004016
5106917	14" 355 mm	18	5602482004023
5106918	18" 460mm	12	5602482004030
5106919	24" 609 mm	6	5602482004047
5106920	36" 915 mm	4	5602482018013
5114385	48" 1.220 mm	1	5602482046771

STILLSON TYPE PIPE WRENCH (EXTRA)



Code	Ref.		EAN
5109860	10" 255 mm		5602482021754
5109861	12" 300 mm		5602482021761
5109862	14" 355 mm		5602482021778
5109863	18" 460mm		5602482021785
5109864	24" 609 mm		5602482021792
5109865	36" 915 mm		5602482015937

BOLT CUTTERS



Code	Ref.		EAN
5106609	WD-05 14" 355 mm	24	5602482013773
5106610	WD-05 18" 460 mm	12	5602482013148
5106611	WD-05 24" 609 mm	12	5602482018488
5106612	WD-05 30" 762 mm	6	5602482018495
5106613	WD-05 36" 915 mm	4	5602482018501

RATCHET



Code	Ref.		EAN
5114753	DS4875 1/4" (155 mm)	6	5602482048751
5114754	DS4876 3/8" (200 mm)	6	5602482048768
5114755	DS4877 1/2" (250 mm)	6	5602482048775

BOLT CUTTER REPLACEMENT BLADE



Code	Ref.		EAN
5108040	WD-05 14" 355 mm	24	5602482016262
5108041	WD-05 18" 460 mm	12	5602482016293
5108042	WD-05 24" 609 mm	12	5602482016804
5108043	WD-05 30" 762 mm	6	5602482017962
5108044	WD-05 36" 915 mm	4	5602482017979

WRECKING BAR



Code	Ref.		EAN
5114759	DS4881	500 x 18 mm	5602482048812
5114760	DS4882	600 x 18 mm	5602482048829
5114761	DS4883	700 x 18 mm	5602482048836
5114762	DS4884	800 x 18 mm	5602482048843
5114763	DS4885	1.000 x 20 mm	5602482048850

HANDSAW



Code	Ref.		EAN
5114648	PSW14/14	350 mm 14"	5602482047778
5114649	PSW14/16	400 mm 16"	5602482047785
5114650	PSW14/18	450 mm 18"	5602482047792
5114651	PSW14/20	500 mm 20"	5602482047808
5114652	PSW14/22	550 mm 22"	5602482047815

BOW SAW



Code	Ref.		EAN
5114653	DS4782	305 mm	5602482047822

TUBE CUTTER



Code	Ref.		EAN
5114757	DS4879	3 - 30 mm	5602482048799

BOW SAW



Code	Ref.		EAN
5114692	DS4801	300 mm	5602482048010

PVC PIPE CUTTER



Code	Ref.		EAN
5114756	DS4878	42 mm	5602482048782

BOW SAW



Code	Ref.		EAN
5114691	DS4800	300 mm	5602482048003

AVIATION SNIPS - RIGHT CUT



Code	Ref.			EAN
5114575	DS-4698	250 mm green	6	5602482046986

AVIATION SNIPS - LEFT CUT



Code	Ref.			EAN
5114574	DS-4697	250 mm red	6	5602482046979

AVIATION SNIPS - STRAIGHT CUT



Code	Ref.			EAN
5114573	DS-4699	250 mm yellow	6	5602482046993

CARPENTER PINCERS



Code	Ref.			EAN
5109643		9" 225 mm	6	5602482012868
5114572		10" 255 mm	6	5602482047259

BUCKET TROWEL - WOOD HANDLE



Code	Ref.		EAN
5113570	404.197 200 mm	6	5602482045255

GAUGING TROWEL - WOOD HANDLE



Code	Ref.		EAN
5113572	409.009 9" 225 mm	6	5602482045248

RUBBER MALLET (BLACK)



Code	Ref.		EAN
5110510	316 40 mm	6	5602482011717

RUBBER MALLET (WHITE)



Code	Ref.		EAN
5113567	317.040 40 mm	6	5602482045040

BALL PEIN HAMMER



Code	Ref.		EAN
5105592	305-E 200 grs.	6	5602482008144
5105593	305-E 300 grs.	6	5602482008151
5105594	305-E 500 grs.	6	5602482008809

CLAW HAMMER (POLISHED FACE)



Code	Ref.		EAN
5105588	127 23 mm	6	5602482009004

PLASTERING TROWEL - PLASTIC HANDLE



Code	Ref.		EAN
5106584	185-2 130 x 280 mm	12	5602482019072

GARDEN SHEARS



Code	Ref.		EAN
5113573	470.012 12" 300 mm	6	5602482045125

SANDING BLOCK (RUBBER)



Code	Ref.		EAN
5105251	DPM 2615	120 x 65 mm 	30 5602482026155



OIL FILTER STRAP WRENCH



Code	Ref.		EAN
5105252	DPM2616	 50	5602482026162

SANDING BLOCK



Code	Ref.		EAN
5105250	DPM2613	160 x 85 mm 	25 5602482026131
5105249	DPM2614	210 x 105 mm 	50 5602482026148



BASIN WRENCH



Code	Ref.		EAN
5106129	DPM2617	 40	5602482026179

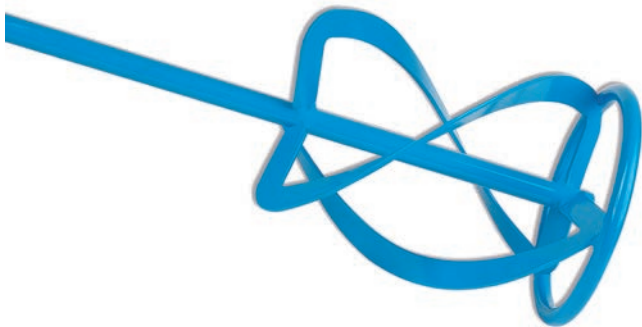

MIXING PADDLE

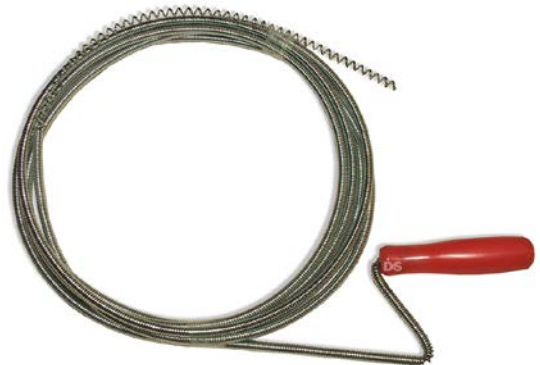

Code	Ref.		EAN
5106809	DPM2590	70 x 400 mm 	30 5602482025905
5101333	DPM2591	100 x 600 mm 	12 5602482025912
5106951	DPM2592	120 x 600 mm 	6 5602482015929

PIPE CLEANING SPIRAL



Code	Ref.		EAN
5106126	040122-1N	3 metres 	30 5602482021501
5106127	040123N	5 metres 	10 5602482004054
5108269	040124N	10 metres 	5 5602482003750

SCORING WHEEL FOR TILE CUTTER



Code	Ref.			EAN
5105246	599211-0501	10 mm	12	5602482016392
5105247	599111-501	18 mm	12	5602482016408

CROSS SHAPED TILE SPACERS



Code	Ref.			EAN
5118719	DPM4093	1 mm (250 un.)	200	5602482040939
5105055	DPM2594	2 mm (250 un.)	200	5602482025943
5105056	DPM2595	3 mm (200 un.)	200	5602482025950
5105057	DPM2596	4 mm (200 un.)	100	5602482025967
5105058	DPM2597	5 mm (200 un.)	100	5602482025974
5110827	DPM3127	6 mm (200 un.)	100	5602482031272
5106130	DPM2598	8 mm (100 un.)	100	5602482025981
5109152	DPM2599	10 mm (100 un.)	100	5602482025998

PLASTIC TILE WEDGES



Code	Ref.			EAN
5118012	DPM3128	30 x 6 x 5 mm (100 un.)	70	5602482031289

OIL FEED GLASS CUTTER



Code	Ref.			EAN
5105059	DPM2620		6	5602482026208

KNEE PADS (RUBBER)



Code	Ref.			EAN
5105523	DPM2600		40	5602482026001

SEALING TAPE



Code	Ref.			EAN
5500733		12 mm x 10 metres	12-1200	5602482032064
5500734		25 mm x 50 metres	1 - 200	5602482004085

GLASS AND TILE SUCTION CUP



Code	Ref.		EAN
5106807	DPM2601	∅ 110 mm	5602482026018

SHARPENING STONE - DOUBLE SIDED



Code	Ref.		EAN
5102091	709	150 x 50 x 25 mm	5602482005150
5102092	709	200 x 50 x 25 mm	5602482005167

DIAMOND HOLE SAW DRILL BIT



Code	Ref.		EAN
5110816	560110	10 mm	5602482029989
5110817	560112	12 mm	5602482029996

SCYTHE STONE



Code	Ref.		EAN
5104597		225 x 35 x 15 mm	5602482020351

GROUTERS FLOAT (RUBBER)



Code	Ref.		EAN
5109546	DPM2621	4" x 9" 100 x 230 mm	5602482026216
5109547	DPM2622	4" x 12" 100 x 300 mm	5602482026223

HOLE SAW ARBOR



Code	Ref.		EAN
5105860	10103001	1/4" 6 mm	5602482028067

HOLE SAW ARBOR



Code	Ref.		EAN
5105861	10103008	7/16" 11 mm	5602482028074

PILOT DRILL



Code	Ref.		EAN
5106177	10104008	for 1/4" and 7/16" arbours	5602482028050

SDS MAX EXTENSION | FOR SDS HOLE SAWS



Code	Ref.		EAN
5114378	268000350	350 mm	5602482046726
5114379	268000450	450 mm	5602482046733

CARBIDE HOLE SAW DRILL



Code	Ref.		EAN
5111809	26900030	30 mm	5602482041707
5111810	26900035	35 mm	5602482041714
5111811	26900040	40 mm	5602482041721
5111812	26900045	45 mm	5602482041738
5111813	26900050	50 mm	5602482041745
5111814	26900055	55 mm	5602482041752
5111815	26900060	60 mm	5602482041769
5111816	26900065	65 mm	5602482041776
5111817	26900070	70 mm	5602482041783
5111818	26900075	75 mm	5602482041790
5111819	26900080	80 mm	5602482041806
5111820	26900085	85 mm	5602482041813
5111821	26900090	90 mm	5602482041820
5111822	26900095	95 mm	5602482041837
5111823	26900100	100 mm	5602482041844
5111824	26900105	105 mm	5602482041851
5111825	26900110	110 mm	5602482041868
5111826	26900120	120 mm	5602482041875
5114380	26900130	130 mm	5602482046689
5114381	26900150	150 mm	5602482046696

SDS PLUS EXTENSION | FOR SDS HOLE SAWS



Code	Ref.		EAN
5114376	267000350	350 mm	5602482046702
5114377	267000450	450 mm	5602482046719

SDS MAX FLAT CHISEL



Code	Ref.		EAN
5118579	451205	Ø 18 x 25 x 300 mm	5602482047266
5118580	451260	Ø 18 x 25 x 400 mm	5602482047273
5118520	451207	Ø 18 x 25 x 600 mm	5602482047280
5118581	451206	Ø 18 x 50 x 400 mm	5602482047297

SDS PLUS FLAT CHISEL



Code	Ref.		EAN
5118574	451242	Ø 14 x 20 x 250 mm	5602482047303
5118575	451221	Ø 18 x 40 x 250 mm	5602482047310

SDS MAX POINTED CHISEL



Code	Ref.		EAN
5118576	451201	Ø 18 x 250 mm	5602482047327
5118577	451258	Ø 18 x 400 mm	5602482047334
5118578	451202	Ø 18 x 600 mm	5602482047341

BURIN POINTU SDS PLUS



Code	Ref.		EAN
5119573	451240	Ø 14 x 250 mm	5602482047358

SDS PLUS ADAPTOR



Code	Ref.		EAN
5112902	26714001	1/2" x 20 UNF	5602482043107

HSS STEP DRILL BIT

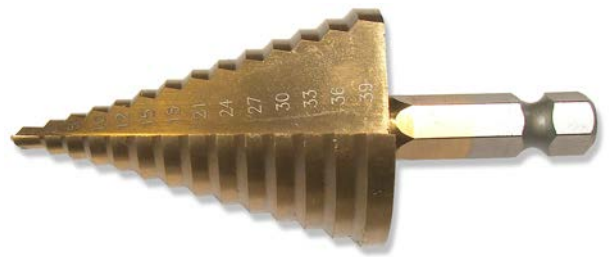

Drills perfect holes into steel, copper, brass, aluminium, wood and plastic.

Size:

9 holes: 4 - 6 - 8 - 10 - 12 - 14 - 16 - 18 - 20 mm

14 holes: 4 - 6 - 8 - 10 - 12 - 15 - 18 - 21 - 24 - 27 - 30 - 33 - 36 - 39 mm

Code	Ref.		EAN
5114606	13009082	Ø 4 to 20 mm 9 holes	4 5602482047389
5110760	13014000	Ø 4 to 39 mm 14 holes	4 5602482029729

SHEET METAL PUNCH



Code	Ref.		EAN
5110807	21600032	32 mm	10 5602482047365
5110806	21600035	35 mm	10 5602482047372

COUNTERSINK DRILL BIT



Size:
6,3/ 8,3/ 10,4/ 12,4/ 16,5/ 20,5 mm

Code	Ref.		EAN
5112878	13500006	6 pieces	5602482042865

COUNTERSINK DRILL BIT



DIN 335
Perfect for milling different types of materials, such as iron, steel, plastic or wood.

Code	Ref.		EAN
5112876	13600124	12,4 mm 8 mm shank	5602482042841
5112877	13600190	19 mm 10 mm shank	5602482042858

BORING DRILL BIT



Made of carbon steel for precision finishing. For drilling into hardwood, pressed cardboard and plastic.

Code	Ref.		EAN
5112879	48030526	26 x 50 mm 8 mm shank	5602482042872
5112880	48030530	30 x 50 mm 8 mm shank	5602482042889
5112881	48030535	35 x 50 mm 8 mm shank	5602482042896

HSS TAP



Code	Ref.		EAN
5112882	18600030	M 3 (set 3 pieces)	5602482042902
5112883	18600040	M 4 (set 3 pieces)	5602482042919
5112884	18600050	M 5 (set 3 pieces)	5602482042926
5112885	18600060	M 6 (set 3 pieces)	5602482042933
5112886	18600070	M 7 (set 3 pieces)	5602482042940
5112887	18600080	M 8 (set 3 pieces)	5602482042957
5112888	18600100	M10 (set 3 pieces)	5602482042964
5112889	18600120	M12 (set 3 pieces)	5602482042971
5112890	18600140	M14 (set 3 pieces)	5602482042988
5112891	18600160	M16 (set 3 pieces)	5602482042995
5112892	18600180	M18 (set 3 pieces)	5602482043008
5112893	18600200	M20 (set 3 pieces)	5602482043015

RATCHET TYPE TAP WRENCH



Code	Ref.		EAN
5112870	19600001	No.1 M3 to M10	5602482042780
5112871	19600002	No.2 M5 to M12	5602482042797

TRADITIONAL TAP WRENCH



Code	Ref.		EAN
5112782	19700010	No.0 M1 to M8	5602482042803
5112873	19700020	No.1 M3 to M10	5602482042810
5112874	19700040	No.2 M4 to M12	5602482042827
5112875	19700050	No.3 M5 to M20	5602482042834

BI-METAL HOLESAWS



Code	Ref.			EAN
5105826	10101014	14 mm	10	5602482029163
5105827	16101016	16 mm	10	5602482028852
5105828	10101019	19 mm	10	5602482028340
5105829	10101022	22 mm	10	5602482028098
5105830	10101025	25 mm	10	5602482028104
5105831	10101028	28 mm	10	5602482028111
5105832	10101032	32 mm	10	5602482028128
5105833	10101035	35 mm	10	5602482028135
5105834	10101038	38 mm	10	5602482028142
5105835	10101041	41 mm	10	5602482029170
5105836	10101044	44 mm	10	5602482028159
5105837	10101048	48 mm	10	5602482028166
5105838	10101051	51 mm	10	5602482028746
5105839	10101054	54 mm	10	5602482028173
5105840	10101057	57 mm	10	5602482029187
5105841	10101060	60 mm	10	5602482028869
5105842	10101064	64 mm	10	5602482028180
5105843	10101067	67 mm	10	5602482028197
5105844	10101070	70 mm	10	5602482028876
5105845	10101073	73 mm	10	5602482028203
5105846	10101086	76 mm	10	5602482028883
5105847	10101079	79 mm	10	5602482028210
5105848	10101083	83 mm	10	5602482028227
5105849	10101086	86 mm	10	5602482029194
5105850	10101089	89 mm	5	5602482029200
5105851	10101092	92 mm	5	5602482029217
5105852	10101095	95 mm	5	5602482029224
5105853	10101098	98 mm	5	5602482029231
5105854	10101102	102 mm	5	5602482028234
5105855	10101108	108 mm	5	5602482028845
5105856	10101114	114 mm	5	5602482028890
5105857	10101121	121 mm	5	5602482028241
5105858	10101127	127 mm	5	5602482028258

WOOD HOLE SAW SET



Contents:
8 hole saws (19 to 64 mm) / arbours
/ 1 flat drill bit (25 mm) / 1 hexagon key

Code	Ref.			EAN
5112894	56100013	13 pieces 19 to 64 mm		5602482043022

WOOD HOLE SAW SET



Contents:
12 hole saws (19 to 127 mm) / arbours / 1 hexagon key

Code	Ref.			EAN
5114982	56100016	16 pcs. 19 a 127 mm		5602482050648

BI-METAL HOLESAWS



Contents:
11 hole saws (19 to 76 mm)
2 hole saw arbours (1/4" and 7/16")
1 adaptor

Code	Ref.			EAN
5105859	10105012	14 pieces 19 to 76 mm		5602482028081

HOLE SAW



Size:
25, 32, 38, 45, 50, 56 et 62 mm

Code	Ref.		EAN
5110639	56100007	25 mm (7 blades)	5602482030428
5110640	56101007	50 mm (7 blades)	5602482030435

RATCHET THREADER SET



Code	Ref.		EAN
5104868	1/2" to 1.1/4"	4	5602482015531

TUNGSTEN CARBIDE GRIT HOLE SAW

Contents:
8 hole saws (33 to 103 mm)
1 pilot drill + holder



Code	Ref.		EAN
5110857	9 pieces 33 to 103 mm		5602482030442

RATCHET THREADER DIE HEADS



Code	Ref.		EAN
5104870	3/4"		5602482024564
5104869	1/2"		5602482024557
5104871	1"		5602482024540
5104872	1.1/4"		5602482024533

WOOL POLISHING BONNET



Code	Ref.		EAN
5114981	61202102	Ø 125 mm	5602482050464
	61202104	Ø 180 mm	5602482052538

DOEWE PIN



Code	Ref.		EAN
5114904	29050000	Ø 6 x 30 mm 100 unid.	5602482050594
5114905	29070000	Ø 8 x 40 mm 100 unid.	5602482050600
5114906	29090000	Ø 10x40 mm 100 unid.	5602482050617

GLASS AND CERAMIC DRILL



Code	Ref.		EAN
5114965	26400108	3 x 60mm	5602482050471
5114966	26400532	4 x 60 mm	5602482050488
5114967	26400316	5 x 60 mm	5602482050495
5114968	26400104	6 x 70 mm	5602482050501
5114969	26400516	8 x 80 mm	5602482050518
5114970	26400308	10 x 85 mm	5602482050525
5114971	26401532	12 x100 mm	5602482050532

MOUNTED STONE SET



Code	Ref.		EAN
5114907	19500005	shank 6 mm 5 pcs.	5602482050730

MOUNTED STONE SET



Code	Ref.		EAN
5114908	19500010	shank 6 mm 10 pcs.	5602482050747

SDS PLUS DRILL



10 drill: 5 e 6x110mm; 8, 10 e 12x160mm: 10 e 12x210mm; 10, 12 e 16x450mm
Point chisel: 250 mm
Flat chisel: 20x250mm

Code	Ref.		EAN
5116058	26000012	12 pcs	5602482050549

PUNCH SET



Punch:
9.5x2x150mm / 9.5x3x150mm /
9.5x4x150mm / 9.5x5x150mm /
12x6x150mm / 12x8x150mm

Code	Ref.		EAN
5114972	50100006	6 pcs.	5602482050324

CHISEL AND PUNCH SET



Flat chisel: 12x130mm; 15x150mm;
Cap chisel: 3x120mm
Drift chisel: 3x120mm, 4x150mm
Centre punch: 4x130mm

Code	Ref.		EAN
5114973	50110007	6 pcs.	5602482050631

SPADE WOOD DRILL



Code	Ref.		EAN
5115028	8 mm		5602482056374
5117867	10 mm		5602482026544
5117868	12 mm		5602482026551
5117869	14 mm		5602482026568
5117870	16 mm		5602482026575
5117871	18 mm		5602482026582
5117872	20 mm		5602482026599
5117873	22 mm		5602482026605
5117874	24 mm		5602482026612
5117875	25 mm		5602482026629
5115029	26 mm		5602482056619
5117876	28 mm		5602482026636
5117877	30 mm		5602482026643
5117878	32 mm		5602482026650
5117879	35 mm		5602482026667
5117880	38 mm		5602482026674

SPADE WOOD DRILL



Code	Ref.		EAN
5110791	6 pcs.		5602482030275

HOLLOW PUNCHES

NEW



Code	Ref.		EAN
5116240	2 mm 44 gr.	6	5602482059214
5116241	3 mm 47 gr.	6	5602482059221
5116242	4 mm 48 gr.	6	5602482059238
5116243	5 mm 67 gr.	6	5602482059245
5116244	6 mm 69 gr.	6	5602482059252
5116245	8 mm 94 mm	6	5602482059269
5116246	10 mm 126 gr.	6	5602482059276
5116247	11 mm 126 gr.	6	5602482059283
5116248	12 mm 128 gr.	6	5602482059290
5116249	13 mm 170 gr.	6	5602482059306
5116250	14 mm 175 gr.	6	5602482059313
5116251	15 mm 177 gr.	6	5602482059320
5116252	16 mm 181 gr.	6	5602482059337
5116253	17 mm 229 gr.	6	5602482059344
5116254	18 mm 230 gr.	6	5602482059351
5116255	19 mm 237 gr.	6	5602482059368
5116256	20 mm 303 gr.	6	5602482059375
5116257	21 mm 308 gr.	6	5602482059382
5116258	22 mm 311 gr.	6	5602482059399
5116259	23 mm 364 gr.	6	5602482059405
5116260	24 mm 369 gr.	6	5602482059412
5116261	25 mm 370 gr.	6	5602482059429
5116262	26 mm 371 gr.	6	5602482059436
5116263	27 mm 464 gr.	6	5602482059443
5116264	30 mm 591 gr.	3	5602482059450

HOLLOW PUNCHES

NEW



10 DIN 7200 hollow punches in special steel, lacquered, in the following sizes:
• 2; 4; 6; 8; 10; 12; 14; 16; 18 e 20 mm

Code	Ref.		EAN
5116265	10 pcs		5602482059467

HYDRAULIC BOTTLE JACKS

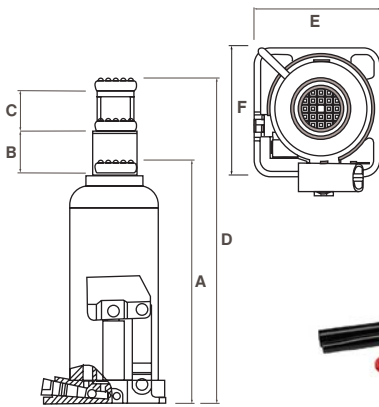

Reference	DS90204X	DS90304X	TH90504S	DS90804X	DS91004X	TH91204	DS91504X	DS92004X	TH93204	TH95004
Code	5116205	5116206	5105903	5116208	5116209	5105906	5116211	5116212	5107826	5107827
Capacity	2 ton.	3 ton.	5 ton.	8 ton.	10 ton.	12 ton.	15 ton.	20 ton.	30 ton.	50 ton.
A	168 mm	188 mm	207 mm	222 mm	222 mm	230 mm	230 mm	240 mm	260 mm	280 mm
B	108 mm	115 mm	125 mm	145 mm	145 mm	150 mm	150 mm	150 mm	160 mm	170 mm
C	48 mm	60 mm	70 mm	80 mm	80 mm	80 mm	80 mm	60 mm	-	-
D	316 mm	363 mm	42 mm	447 mm	450 mm	460 mm	460 mm	450 mm	420 mm	450 mm
E x F (mm)	94.5 x 78	108.5 x 87	117 x 97	124 x 106	124 x 106	134.5 x 115	141 x 118	160 x 140	185 x 165	207 x 185
Pack	6	6	4	4	4	3	2	2	1	1
EAN	5602482054561	5602482054578	6922539896302	5602482054592	5602482054608	6922539896234	5602482054622	5602482054639	6922539896272	6922539896289

HYDRAULIC TROLLEY JACK- LOW PROFILE



Features

Capacity	2,5 ton
Min. height	87 mm
Max. height	455 mm
Weight	33 kg
Dimensions	640 x 342 x 175 mm

Code	Ref.		EAN
5114857	TZ830018	2,5 tons	6922539883180

HYDRAULIC TROLLEY JACK



Features

Capacity	2 ton
Min. height	130 mm
Max. height	350 mm
Weight	10,5 kg
Dimensions	500 x 200 x 125 mm

Code	Ref.		EAN
5105919	T82004S	2 tons	6922539882244

HYDRAULIC TROLLEY JACK



Features

Capacity	2.1/4" ton
Min. height	145 mm
Max. height	520 mm
Weight	36,5 kg
Dimensions	695 x 344 x 180 mm

Code	Ref.			EAN
5105909	T82257	2.1/4" tons	1	5602482018037

HYDRAULIC TROLLEY JACK - EXTENDED HEIGHT



Features

Capacity	2,5 / 3 ton
Min. height	150 mm
Max. height	530 mm
Weight	19 kg / 21 kg
Dimensions	640 x 230 x 220 mm

Code	Ref.			EAN
5114858	T83006B	2,5 tons	1	6922539882138
5106607	T83006B	3 tons	1	5602482029149

HYDRAULIC TROLLEY JACK - QUICK LIFT



Features

Capacity	3 ton
Min. height	145 mm
Max. height	500 mm
Weight	38 kg
Dimensions	685 x 346 x 180 mm

Hydraulic trolley jack with an instant lift foot pedal.

Code	Ref.			EAN
5106170	T83502	3 tons	1	5602482018044

JACK STANDS

2 tons
Minimum height:
290mm
Maximum height:
375mm



Code	Ref.		EAN
5117622	DS5687HM2T 2 ton.		5602482056879

HYDRAULIC BODY REPAIR KIT



Code	Ref.		EAN
5105918	T71001S 10 toneladas	1	5602482009233

CAVALETE AUTO | PROFESSIONAL
BORRIQUETA DE CREMALLERA

3 tons
Minimum height:
290mm
Maximum height:
420mm



Code	Ref.		EAN
5117624	DS2623HM3T 3 toneladas		5602482026230

PANEL BEATING SET



Code	Ref.		EAN
5106783	7 pcs.	4	5602482018709

FOLDING ENGINE CRANE



Features		
Capacity	1 tone	2 tons
Lifting	25 ~2.040 mm	25 - 2240 mm
Length	1.510 mm	1.550 mm
Width	1.015 mm	1.450 mm
Height	1.545 mm	2.200 mm
Nominal Load	250/500/ 750/1.000 kg	500/1.000/ 1.500/2.000 kg
Length of jib	1.250/1.160/ 1.070/980 mm	
Minimum height	178 mm	
Weight	65 kg	

This product has been specially designed to lift, lower and transport engines, differentials, transmissions and other heavy loads with minimum effort.

- Adjustable lift arm.
- Tubular frame made of thick steel.
- Foldable for easy storage.

Code	Ref.			EAN
5114237	T31002X-GS 1 tonE		1	5602482029132
5109556	DS1492HM 2 tonel		1	5602482014923

HAND PALLET TRUCK



Features	
Capacity	2.200 kg
Lift height	200 mm
Fork length	1.150 mm
Fork width	525 mm
Steering wheel size	200 x 45 mm
Load wheel size	82 x6 0 mm
Weight	63 kg

Hydraulic system. Spherical connection between the shaft and the pump piston. Easy to manoeuvre within to 210-degree turning radius. Special lowering valve to control the rate of descent and overload valve that makes it more resistant and durable. Lift per one manual stroke: 12mm

Code	Ref.			EAN
5114498	GS25S4 2,5 tons		1	5602482029125

HAND CHAIN HOIST



Features	HSZ-0,5T	HSZ-1T	HSZ-2T
Capacity	0,5 toneladas	1 tonelada	2 toneladas
Standard lifting height	2,5 m	2,5 m	2,5 m
Load test (max.)	0,75 ton.	1,5 ton.	3 ton.
Minimum height (hook to hook)	270 mm	270 mm	444 mm
Stress (N)	225	309	314
Chain length	3 m	3 m	3 m
Chain diameter	6 mm	6 mm	6 mm
Number of chain turns	1	1	2
Net weight	9,5 kg	10 kg	14 kg

Code	Ref.		EAN
5105916	HSZ-0,5T	0,5 ton.	5602482021174
5105917	HSZ-1T	1 ton.	5602482021181
5101052	HSZ-02T	2 ton.	5602482017788

ROTARY PUMP



Code	Ref.		EAN
5105910	TR8020	2 ton cable: 4 m x Ø 5 mm	5602482006102
5105911	TR8041	4 ton cable: 4 m x Ø 5 mm	5602482008205

CABLE RATCHET PULLER



Suction tube: 980 mm

Code	Ref.		EAN
5106795		flow rate: 30 litres/minute	5602482013605

TOOL TROLLEY



Dimensions

Table: 737x383x663 mm
Trays: 735x380x85 mm

Code	Ref.		EAN
5105915	TC302	load capacity: 136 kg	5602482020962

FLOOR STANDING PARTS WASHER



Pump for part washer:

Maximum height: 1,8 metres
Maximum flow rate: 1.000 litres/hour
Max. water temperature: 35°C

Code	Ref.		EAN
3004069	DS5470-CP	pump	5602482054707
3008331	DS5469-BH	brush with hose	5602482054691

FLOOR STANDING PARTS WASHER | 5 GALLON



Features:

Washing tank: 430x340x220 mm
Capacity: 19 Liters
Solvent capacity: 13 Liters
Pump flow: 2.7/3.3 lit./min.
Dimensions: 470x360x250 mm
Weight: 6,5 kg

Code	Ref.		EAN
5118824	DS5468G5	capacity: 5 gal. 19 lit.	5602482054684

FLOOR STANDING PARTS WASHER | 20 GALLON



Features:

Washing tank: 760x520x300 mm
Capacity: 75 Liters
Solvent capacity: 45 Liters
Pump flow: 2.7/3.3 lit./min.
Dimensions: 790x550x320 mm
Weight: 28 kg

Code	Ref.		EAN
5101271	DS3533G20	capacity: 20 gal. 75 lit.	5602482035331

DRYWALL LIFT



Features

Maximum capacity	70 kg
Maximum height	3.300 mm
Dimension gypsum plasterboards	1.1200 x 4.800 mm
Largura da base	1.550 mm
Base width	1.450 mm
Pe Weight so	38 kg

Manual plasterboard lifter for installing plasterboard at various angles, both on ceilings and walls. Stable 3-support base with wheels. 360° swivel wheel with brake for better control and direction of the plasterboard.

Code	Ref.			EAN
5117623	DS5636HM	Placas 1.20 x 4.80 mt.	1	5602482056367



OIL CAN | FLEXIBLE SPOUT



Steel oil can, with the seamless body designed from tin coated sheet metal with a premium powder coated finish. Steel pump.

Code	Ref.		EAN
5116159	DS5689GZ	125 ml Spout 125 mm	5602482056893
5116160	DS5690GZ	180 ml Spout 125 mm	5602482056909

OIL CAN | RIGID SPOUT



Steel oil can, with the seamless body designed from tin coated sheet metal with a premium powder coated finish. Steel pump.

Code	Ref.		EAN
5116164	DS5694GZ	125 ml Spout 100 mm	5602482056947
5116165	DS5695GZ	180 ml Spout 100 mm	5602482056954

OIL CAN | FLEXIBLE SPOUT



Steel oil can, with the seamless body designed from tin coated sheet metal with a premium powder coated finish. Steel pump.

Code	Ref.		EAN
5116161	DS5691GZ	300 ml Spout 150 mm	5602482056916
5116162	DS5692GZ	400 ml Spout 175 mm	5602482056923
5116163	DS5663GZ	500 ml Spout 175 mm	5602482056930

OIL CAN | RIGID SPOUT



Steel oil can, with the seamless body designed from tin coated sheet metal with a premium powder coated finish. Steel pump.

Code	Ref.		EAN
5116166	DS5696GZ	300 ml Spout 125 mm	5602482056961
5116167	DS5697GZ	400 ml Spout 150 mm	5602482056978
5116168	DS5668GZ	500 ml Spout 150 mm	5602482056985

FLEXIBLE SPOUT



Code	Ref.		EAN
5116173	DS5703GZ	125 mm	5602482057036
5116174	DS5704GZ	175 mm	5602482057043

RIGID SPOUT



Code	Ref.		EAN
5116175	DS5705GZ	100 mm	5602482057050
5116176	DS5706GZ	150 mm	5602482057067

SQUEEZE BOTTLE OIL CAN



Low density polyethylene body is unbreakable, lightweight and corrosion resistant. Made of translucent white material.
Recommended use: Water, water-based liquids, alcohol, soaps, plants, nutrient solution, light and heavy oils.

Code	Ref.		EAN
5116169	DS5699GZ 125 ml		5602482056992
5116170	DS5700GZ 250 ml		5602482057005
5116171	DS5701GZ 500 ml		5602482057012
5116172	DS5702GZ 1 Liter		5602482057012

CONICAL PLASTIC FUNNEL



Material: Polypropylene
For industry and workshop use with diesel, petrol, paraffin, urea, oils, antifreeze and other water-based media.
Do not use with:
Acids and at temperatures above 60°C

Code	Ref.		EAN
5116184	DS5714GZ 650 ml Ø 146 mm		5602482057142

FUEL AND OIL FUNNEL



Material: Polipropileno de alta densidade
Utilização recomendada:
Diesel, gasolina, querosene, ureia, água e anticongelantes.

Code	Ref.		EAN
5116185	DS5715GZ 4,5 lit. 280x190 mm		5602482057159

PLASTIC FUNNEL SET



Material: Polypropylene
Optimal The high rim acts as an effective splash guard.
Recommended Use: Diesel fuel, gasoline, paraffin, urea, oils, antifreeze and other water based media.
Do not use with: Acids and at temperatures above 60°C

Code	Ref.		EAN
5116183	DS5713GZ 50; 75; 100 e 125 ml		5602482057135

MEASURING JUG



Practical measuring jugs suitable for industrial and automotive applications
Material: Transparent polypropylene
Temperature ranges:
-10° C to max +120° C
Compatibility:
Resistant to oil and acids (strong and concentrated), bases and chemicals.
Food industry compatible.

Code	Ref.		EAN
5116186	DS5716GZ 600 ml		5602482057166
5116187	DS5717GZ 1 Liter		5602482057173
5116188	DS5718GZ 2 Liters		5602482057180
5116189	DS5719GZ 5 Liters		5602482057197

FLEXIBLE SPOUT MEASURE



Material: High density polyurethane

Temperature ranges:

-10° C to max +120° C

Features:

Used to transfer the measured quantity of fluids. The 8 litre measure is especially useful for transferring oils to the engine / transmission system of trucks and heavy vehicles.

Code	Ref.		EAN
5116190	DS5720GZ	1 Liter	5602482057203
5116191	DS5721GZ	2 Liters	5602482057210
5116192	DS5722GZ	3 Liters	5602482057227
5116193	DS5723GZ	5 Liters	5602482057234

MINI PISTOL GREASE GUN



The choice of materials (stainless steel/ aluminium) makes this gun ideal for use in marine work.



Code	Ref.		EAN
5116178	DS5708GZ	85 grams	5602482057081

PUSH TYPE GREASE GUN



- Bomba de grassar metálica e compacta.
- Ideal para lubrificar chaves de impacto, máquinas de relva, motosserras, reboque, automóveis e camiões.

Mecanismo do tipo "push" para utilização apenas com massa lubrificante a granel.

- Bomba de grasa metálica compacta.
- Ideal para lubrificar llaves de impacto, máquinas cortacésped, motosierras, vehículos de remolque, coches y camiones.

Mecanismo de empuje para uso exclusivo con grasa a granel.

Code	Ref.		EAN
5116177	DS5707GZ	200 grams 125cm ³	5602482057074

PISTOL GREASE GUN



Grease pump designed for use in confined spaces where access to the grease Spout is restricted

- Heavy duty construction
- Pump body with 1,2 mm wall thickness
- High tolerance head
- Super strong pistol grip



Code	Ref.		EAN
5116179	DS5709GZ	500cm ³ 400 grams	5602482057098

LEVER GREASE GUN



Die-cast aluminium head equipped with automatic air bleed valve. Black powder-coated finish. Ergonomic rubber grip.

Code	Ref.		EAN
5116180	DS5710GZ	500cm ³ 400 grams	5602482057104

BOMBA LUBRIFICAR PNEUMÁTICA

BOMBA ENGRASE AIRE COMPRIMIDO



Ideal para utilização na manutenção de fábricas, explorações agrícolas, serviço de frotas ou para utilização em camiões ligados a compressores de travões a ar. Cabeça em alumínio fundido de alta resistência com furo interno de precisão aperfeiçoado para uma acção rápida. Equipada com válvula de carga. Pistola ergonómica com ângulo da cabeç para maior facilidade de operação, especialmente em espaços estreitos

Pressão de ar: 3 - 8 BAR | 40 - 120 PSI
 Entrada ar: 1/4" (F)
 Volume curso: 0,026 m³ @ 6 bar
 Fornecido com: extensão metálica 150 mm (6") e agrafe 4 garras

Ideal para su uso en el mantenimiento de fábricas, explotaciones agrícolas, servicio de flotas o para su uso en camiones conectados a compresores de frenos de aire. Cabeza de fundición de aluminio de alta resistencia con orificio de precisión optimizado para una acción rápida. Equipado con una válvula de carga. Pistola ergonómica con cabezal en ángulo para facilitar el manejo, especialmente en espacios reducidos

Presión de aire: 3 - 8 BAR | 40 - 120 PSI
 Entrada de aire: 1/4" (F)
 Volumen de carrera: 0,026 m³ @ 6 bar
 Se suministra completo con: 150 mm (6") y 4 grapas de sujeción

Code	Ref.		EAN
5116181	DS5711GZ	500cm ³ 400 grams	5602482057111

ROTARY PUMP



Recommended use: Heating oil, engine oil, self-lubricating and non-aggressive materials, petroleum, diesel, paraffin, etc.

Telescopic steel suction tube for use in 50 and 200 Liters drums.

Components:

Steel, cast iron and NBR (nitrile rubber).

Not to be used with:

Antifreeze, acids, petrol, etc.

Inlet: 1"

Outlet: 3/4"

Code	Ref.		EAN
5116182	DS5712GZ	Flow: 30 lit./min.	5602482057128



HYDRAULIC COUPLER | 4 JAWS



Measures: Ø 15 x 37 mm

Code	Ref.		EAN
5116158	DS5688GZ 1/8" Ø 15mm		5602482056886

GREASE GUN HOSE



Thermoplastic hose material

Code	Ref.		EAN
5116194	DS5724GZ 1/8" Ø 8,5x300 mm		5602482057241

GREASE GUN HOSE



Polyamide hose coated with polyurethane

Code	Ref.		EAN
5116195	DS5725GZ 1/8" Ø 11x300 mm		5602482057258
5116196	DS5726GZ 1/8" Ø 11x500 mm		5602482057265

GREASE GUN STEEL EXTENSION



Galvanised steel extension

Code	Ref.		EAN
5116197	DS5727GZ 1/8" Ø 10x150 mm		5602482057272

SUCTION GUN



SUC

Usable for draining and filling non-corrosive liquids and emptying tanks on vehicles and machines such as gearboxes, axles, etc.

Code	Ref.		EAN
5116198	DS5728GZ 500 ml		5602482057289

SUCTION GUN



Usable for draining and filling non-corrosive liquids and emptying tanks on vehicles and machines such as gearboxes, axles, etc.

Code	Ref.		EAN
5116199	DS5729GZ 1.000 ml		5602482057296

TRANSFER GUN



Usable for draining and filling non-corrosive liquids and emptying tanks on vehicles and machines such as gearboxes, axles, etc.

Code	Ref.		EAN
5116200	DS5730GZ 500 ml		5602482057302

HALF ROUND WOOD RASP - RUBBER HANDLE



Code	Ref.		EAN
5110646	DS2985-1	6" 150 mm BASTARD	6 5602482029859
5110647	DS2986-1	8" 200 mm BASTARD	6 5602482029866
5110648	DS2987-1	10" 255 mm BASTARD	6 5602482029873
5110649	DS2988-1	12" 300 mm BASTARD	6 5602482029880

FLAT FILE - RUBBER HANDLE



For smoothing flat surfaces and sharp edges.

Code	Ref.		EAN
5101065	DS2231-1	6" 150 mm BASTARD	6 5602482022317
5101066	DS2232-1	8" 200 mm BASTARD	6 5602482022324
5114253	DS4645-1	10" 250 mm BASTARD	6 5602482046450
5101319	DS4646-3	6" 150 mm SMOOTH	6 5602482046467
5101320	DS2235-3	8" 200 mm SMOOTH	6 5602482022355
5101321	DS2236-3	10" 250 mm SMOOTH	6 5602482022362

HALF ROUND FILE - RUBBER HANDLE



For smoothing hollow surfaces and large holes.

Code	Ref.		EAN
5101056	DS2222-1	6" 150 mm BASTARD	6 5602482022225
5101057	DS2223-1	8" 200 mm BASTARD	6 5602482022232
5101058	DS2224-1	10" 250 mm BASTARD	6 5602482022249
5114246	DS4637-3	6" 150 mm SMOOTH	6 5602482046375
5114247	DS4638-3	8" 200 mm SMOOTH	6 5602482046382
5114248	DS2639-3	10" 250 mm SMOOTH	6 5602482046399

EXTRA SLIM TRIANGULAR FILE - RUBBER HANDLE



For smoothing hollow surfaces and large holes in wood, plastic ...

Code	Ref.		EAN
5114254	DS4647-2	4" 100 mm	6 5602482046474

FLAT FILE - RUBBER HANDLE



For smoothing flat surfaces and sharp edges, more effective in hard to reach areas.

Code	Ref.		EAN
5114249	DS4640-1	6" 150 mm BASTARD	6 5602482046405
5101060	DS4641-1	8" 200 mm BASTARD	6 5602482046412
5114250	DS4642-1	10" 250 mm BASTARD	6 5602482046429
5114251	DS4643-3	6" 150 mm SMOOTH	6 5602482046436
5101315	DS2229-3	8" 200 mm SMOOTH	6 5602482022294
5114252	DS4644-3	10" 250 mm SMOOTH	6 5602482046443

SLIM TRIANGULAR FILE - RUBBER HANDLE



For the sharpening of saws with oblique teeth (60°).

Code	Ref.		EAN
5101072	DS2238-2	4" 100 mm	6 5602482022386
5101073	DS2239-2	5" 125 mm	6 5602482022393

TRIANGULAR FILE - RUBBER HANDLE



For the sharpening of saws with oblique teeth (60°).

Code	Ref.			EAN
5101074	DS4648-2	4" 100 x 9 mm	6	5602482046481
5114255	DS4649-2	5" 125 mm	6	5602482046498
5101076	DS2243-2	6" 150 mm	6	5602482022430
5101077	DS2244-2	7" 175 mm	6	5602482022447
5101078	DS2245-2	8" 200 mm	6	5602482022454

NEEDLE FILES



Code	Ref.			EAN
5101082	DS4650-1	6" 150 mm BASTARD	6	5602482046504
5101083	DS2250-1	8" 200 mm BASTARD	6	5602482022508
5101084	DS2251-1	10" 250 mm BASTARD	6	5602482022515
5101322	DS2246-3	6" 150 mm SMOOTH	6	5602482022461
5101323	DS2247-3	8" 200 mm SMOOTH	6	5602482022478
5114256	DS4651-3	10" 250 mm SMOOTH	6	5602482046511

ROUND FILE



Code	Ref.			EAN
5110731	DS2989	12 pieces 160 mm	6	5602482029897

FOOT PUMP



Code	Ref.		EAN
5112980	801E	with manometer	5602482042773

AUTOMOTIVE CIRCUIT TESTER



Cable Features:
100 amp / Ø 9 mm / Length 2,20 m

Code	Ref.		EAN
5106964	100 amp	20	5602482001831
5106965	400 amp	10	5602482012899
5114230	600 amp	5	5602482046344

DOUBLE CYLINDER FOOT PUMP



Code	Ref.		EAN
5105262	903B	with manometer	5602482010307

SOLDERING IRON



Code	Ref.		EAN
5106970	CDD-D30	30 watt	5602482015258
5106971	CDD-D45	45 watt	5602482008267
5106972	CDD-D60	60 watt	5602482009226
5106973	CDD-D80	80 watt	5602482018518
5114472	CDD-D100	100 watt	5602482046788

SOLDERING GUN



The gun is equipped with an interchangeable stainless steel tip with to heating time of 3 ~ 8 seconds. Designed for intermittent use of 12 seconds per minute, in accordance with international standards (12s / 48s T25E).

Features:
Voltage: 230 V
Frequency: 50 Hz
Degree of insulation: II

Code	Ref.		EAN
5106969	KL-818	100 watt	5602482008779

GLUE GUN



Glue gun for many purposes, such as artificial flower collage, decorating, modelling, carpentry, carpet application, ... Heating time of 3 to 5 seconds with to glue flow of 25 to 35 g/ min.

Code	Ref.		EAN
5112863	FL-288	180 watt	5602482008861

GLUE GUN



Glue gun for many purposes, such as artificial flower collage, decorating, modelling, carpentry, carpet application, ...

Code	Ref.		EAN
5114127	FL-158	40 watt	5602482005495

PROFESSIONAL GLUE GUN



Glue gun with temperature adjustment and display. Supplied with gun stand, two nozzles, glue sticks and to plastic carrying case. Perfect for DIY and gluing jobs in general.

Code	Ref.		EAN
5112864	FL-277	125 watt	5602482042681

GLUE STICKS



Code	Ref.		EAN
5104312	DPM2609	6 units	5602482026094
5104313	dpm2610	12 units	5602482026100

FLOODLIGHT



Floodlight with metallic support, plastic diffuser and 2 fluorescent lamps.

Features:
 Lamp type: 2 G10
 Electrical cable: H05RN-F 3x0,75 mm2
 Cable length: 1,5 metres
 Insulation class: IP44

Code	Ref.		EAN
5110840	KM0501318	2 x 27 watt	5602482030237

GLUE STICKS



Code	Ref.		EAN
5500584	GS130MD		5602482029255

VOLTAGE AND CONTINUITY TESTER



Code	Ref.		EAN
5108917	6895B	10 in 1	5602482006409

CHALK LINE



Metallic chalk line reel with 30 metres of string and to 50 g blue chalk refill bottle.

Code	Ref.		EAN
5109559			5602482005648

EARTH CLAMP



Code	Ref.		EAN
5108469	200 amp	50	5602482021556

EARTH CLAMP



Code	Ref.		EAN
5108470	350 amp	50	5602482021563

BATTERY CLIPS



Code	Ref.		EAN
5108471	(-) black	100	5602482022003
5108476	(+) red	100	5602482022638

DRILL STAND



Code	Ref.		EAN
5112896	80900043	height: 430 mm course: 50 mm	5602482043046

ANGLE GRINDER STAND



Code	Ref.		EAN
5112897	96214	for 115 125 150 mm	5602482043053
5112898	96216	for 180 and 230	5602482043060

DOUBLE OPEN-ENDED SPANNER (CHROME VANADIUM)



Code	Ref.		EAN
5108989	6 pieces 6x7 to 16x17 mm	5	5602482022683
5106205	8 pieces 6x7 to 20x22 mm	5	5602482021570
5108990	10 pieces 6x7 to 24x27 mm	4	5602482022690
5106206	12 pieces 6x7 to 30x32 mm	4	5602482021587

RING SPANNER (CHROME VANADIUM)



Code	Ref.		EAN
5108991	6 pieces 6x7 to 16x17 mm	5	5602482022706
5106207	8 pieces 6x7 to 20x22 mm	5	5602482021594
5108992	10 pieces 6x7 to 24x27 mm	5	5602482022713
5106208	12 pieces 6x7 to 30x32 mm	4	5602482021600

DOUBLE OPEN-ENDED SPANNER (CHROME VANADIUM)



Code	Ref.		EAN
5108967	6 x 7 mm	25	5602482007635
5108968	8 x 9 mm	25	5602482006485
5108969	10 x 11 mm	25	5602482006492
5108970	12 x 13 mm	20	5602482006508
5108971	14 x 15 mm	10	5602482006515
5108972	16 x 17 mm	10	5602482006522
5108973	18 x 19 mm	10	5602482006539
5108974	20 x 22 mm	10	5602482006546
5108975	21 x 23 mm	10	5602482006553
5108993	24 x 26 mm	10	5602482006560
5108973	25 x 28 mm	10	5602482006577
5108977	30 x 32 mm	10	5602482006591

RING SPANNER (CHROME VANADIUM)



Code	Ref.		EAN
5108978	6 x 7 mm	25	5602482006607
5108979	8 x 9 mm	25	5602482006614
5108980	10 x 11 mm	20	5602482006621
5108981	12 x 13 mm	20	5602482006638
5108982	14 x 15 mm	20	5602482006645
5108983	16 x 17 mm	20	5602482006652
5108984	18 x 19 mm	10	5602482006669
5108985	20 x 22 mm	10	5602482006676
5108986	21 x 23 mm	10	5602482006683
5108987	24 x 26 mm	10	5602482006690
5108988	25 x 28 mm	5	5602482006642
5108995	27 x 32 mm	5	5602482006659
5113313	30 x 32 mm		5602482044753

COMBINATION SPANNER (CHROME VANADIUM)

COMBINATION SPANNER (CHROME VANADIUM)



Code	Ref.	EAN
5110650	8 pieces 8 to 19 mm	5 5602482029736
5110645	17 pieces 6 to 22 mm	4 5602482029743
5110644	25 pieces 6 32 mm	2 5602482029750

Code	Ref.	EAN
5101203	6 mm	10 5602482017610
5101204	7 mm	10 5602482017627
5101205	8 mm	10 5602482017634
5101206	9 mm	10 5602482017641
5101207	10 mm	10 5602482017658
5101208	11 mm	10 5602482017665
5101209	12 mm	10 5602482017672
5101210	13 mm	10 5602482017689
5101211	14 mm	10 5602482017696
5101212	15 mm	10 5602482017702
5101213	16 mm	10 5602482017719
5101214	17 mm	10 5602482017726
5101217	18 mm	10 5602482017733
5101220	19 mm	10 5602482017740
5101221	20 mm	10 5602482023475
5101222	21 mm	10 5602482023482
5101223	22 mm	10 5602482023499
5101225	23 mm	10 5602482023505
5101226	24 mm	10 5602482023512
5101227	25 mm	10 5602482023529
5101228	26 mm	10 5602482023536
5101231	27 mm	5 5602482023543
5101232	28 mm	5 5602482023550
5101233	29 mm	5 5602482023567
5101234	30 mm	5 5602482023574
5101235	32 mm	5 5602482023598



TUBULAR BOX SPANNER



Code	Ref.		EAN
5118498	8 pieces 6x7 to 20x22 mm	4	5602482038813

CLÉ TUBULAIRE (CHROME VANADIUM)



Code	Ref.		EAN
5113309	14 x 15 mm	25	5602482044548
5113310	16 x 17 mm	20	5602482044555
5113311	18 x 19 mm	20	5602482044562
5113312	20 x 22 mm	10	5602482044579

TUBULAR BOX SPANNER



Code	Ref.		EAN
5118485	6 x 7 mm	20	5602482038820
5118486	8 x 9 mm	20	5602482038837
5118487	10 x 11 mm	25	5602482038844
5118488	12 x 13 mm	25	5602482038851
5118489	14 x 15 mm	25	5602482038868
5118490	16 x 17 mm	15	5602482038875
5118491	18 x 19 mm	10	5602482038882
5118492	20 x 22 mm	10	5602482038899
5118492	21 x 23 mm	10	5602482038905
5118494	24 x 26 mm	10	5602482038912
5118495	25 x 28 mm	10	5602482038929
5118496	27 x 32 mm	10	5602482038936
5118497	30 x 32 mm	10	5602482038943

NAIL PULLER



Code	Ref.			EAN
5114694	DS4324	300 x 12 mm	5 - 50	5602482043244
5114695	DS4325	300 x 14 mm	5 - 50	5602482043251

LEATHER TOOLS



Code	Ref.			EAN
5114698	DS1176	2 pockets	50	5602482011762

BREAST DRILL



Code	Ref.			EAN
5106209	DS3316	10 mm 3/8"	1 - 10	5602482033160
5106210	DS2042	13 mm 1/2"	1 - 10	5602482020429

LEATHER TOOLS



Code	Ref.			EAN
5114697	DS1177	5 pockets	50	5602482011779

LEATHER TOOLS



Code	Ref.			EAN
5114696	DS1175	11 pockets	25	5602482011755

MESIN PEG



Code	Ref.			EAN
5106602	DS2028	250 mm	5 - 100	5602482020283

LOCKING PIPE VICE

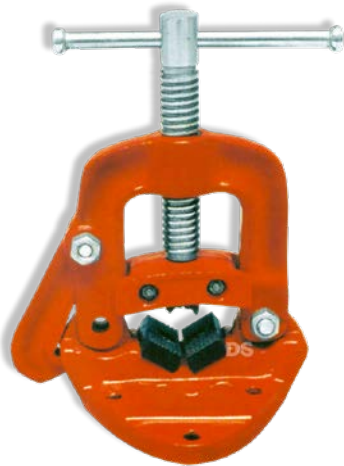

Code	Ref.		EAN
5108618	DS2090	2" 50 mm	5602482020290

CHAIN PIPE VICE



Code	Ref.		EAN
5104590		2" 50 mm	5602482011502

JACK PLANE



Code	Ref.		EAN
5104585	DS1097	N° 3 200 mm	5602482010970
5104586	DS1098	N° 4 225 mm	5602482010987
5104587	DS1099	N° 5 350 mm	5602482010994

BLOCK PLANE



Code	Ref.		EAN
5104588	DS1095	140 mm	5602482010956
5104589	DS1096	175 mm	5602482010963

BEARING PULLER 2 LEGS



Code	Ref.		EAN
5103407	DS0884	3" 75 mm	5602482008847
5103408	DS0358	4" 100 mm	5602482003583
5103409	DS0359	6" 150 mm	5602482003590
5103410	DS0810	8" 200 mm	5602482008106

BEARING PULLER 3 LEGS



Code	Ref.		EAN
5103411	DS0885	3" 75 mm	5602482008854
5103412	DS0360	4" 100 mm	5602482003606
5103413	DS0357	6" 150 mm	5602482003576
5103414	DS1038	8" 200 mm	5602482010383

BEVEL SQUARE



Code	Ref.		Icon	EAN
5104910	DS2255	300 mm	4 - 40	5602482022553

BABY VICE



Code	Ref.		Icon	EAN
5104591	DS1100	2" 50mm	1 - 10	5602482011007
5104592	DS1101	2.1/2" 60 mm	1 - 10	5602482011014

HAMMER HOLDER



Code	Ref.		Icon	EAN
5106211	DS2301	fixe	10 - 50	5602482023017

CARPENTER PINCERS



Code	Ref.		Icon	EAN
5106199	DS1151	9" 225 mm	5 - 50	5602482011519

HAMMER HOLDER



Code	Ref.		Icon	EAN
5106212	DS2254	swivel	10-100	5602482022546

COLD CHISEL



Code	Ref.			EAN
5110442	1063	250 x 16 mm	6	5602482027787
5110443	1064	300 x 16 mm	6	5602482027794
5110444	1065	350 x 16 mm	6	5602482027800

POINT CHISEL WITH HAND GUARD



Code	Ref.			EAN
5110454	1103/43	250 x 16 mm	6	5602482027909
5110455	1104/43	300 x 16 mm	6	5602482027916
5110456	1105/43	350 x 16 mm	6	5602482027923

COLD CHISEL WITH HAND GUARD



Code	Ref.			EAN
5110450	1063/43	250 x 16 mm	6	5602482027824
5110451	1064/43	300 x 16 mm	6	5602482027831
5110452	1065/43	350 x 16 mm	6	5602482027848

SCREW CLAMP



Code	Ref.			EAN
5109055	F1002	50 x 100 mm	50	5602482009912
5109056	F1002	50 x 150 mm	50	5602482009929
5109057	F1002	50 x 200 mm	50	5602482009936
5109058	F1002	50 x 250 mm	50	5602482009943
5109059	F1002	80 x 200 mm	30	5602482009950
5109060	F1002	80 x 250 mm	30	5602482009967
5109061	F1002	120 x 300 mm	10	5602482009974
5109062	F1002	120 x 400 mm	10	5602482009981
5109063	F1002	120 x 500 mm	10	5602482009998
5109064	F1002	120 x 600 mm	10	5602482010000
5109065	F1002	120 x 800 mm	6	5602482010017
5109066	F1002	120 x 1000 mm	6	5602482010024
5110549	F1002	120 x 1200 mm	6	5602482010057

POINT CHISEL



Code	Ref.			EAN
5110446	1103	250 x 16 mm	6	5602482027862
5110447	1104	300 x 16 mm	6	5602482027879
5110448	1105	350 x 16 mm	6	5602482027886

BRICK HAMMER - FIBRE HANDLE



Code	Ref.		EAN
5117854	85608	600 g	5602482018983

MASON'S MALLET - FIBRE HANDLE



Code	Ref.		EAN
5114609	84910	1.000 g	5602482047167

HATCHET - FIBRE HANDLE



Code	Ref.		EAN
5109084	74606	600 g	5602482009813

RUBBER MALLET - FIBRE HANDLE



Code	Ref.		EAN
5109049	65712	12 ounces 360 g	5602482009851
5109050	65716	16 ounces 480 g	5602482009868

AXE - FIBRE HANDLE



Code	Ref.		EAN
5109052	74616	1,600 g	5602482009820

RUBBER MALLET - FIBRE HANDLE



Code	Ref.		EAN
5114607	65812	12 ounces 360 g	5602482047143
5114608	65816	16 ounces 480 g	5602482047150

DEAD BLOW HAMMER - NON REBOUND

NEW



Code	Ref.		Icon	EAN
5118801	64565	Ø 65 mm 1.350 gr.	6	5602482052437
5118802	64575	Ø 75 mm 2 kg.	6	5602482052444

BALL PEIN HAMMER - FIBRE HANDLE



Code	Ref.		Icon	EAN
5109068	24112	12 ounces 360 g	6	5602482007680
5109069	25116	16 ounces 480 g	6	5602482007697
5109070	25124	24 ounces 720 g	6	5602482007703
5109071	25132	32 ounces 960 g	6	5602482007710
5109072	25148	48 ounces 1,450 gr	6	5602482007727

SLEDGE HAMMER - FIBRE HANDLE



Code	Ref.		Icon	EAN
5109080	45208	800 g	12	560248009776
5109081	45210	1,000 g	12	560248009783
5109082	45212	1,250 g	12	560248009790
5109083	44712	1,500 g	12	560248009806

RIP CLAW HAMMER - FIBRE HANDLE



Code	Ref.		Icon	EAN
5117853	15370	700 g	6	5602482018976

SLEDGEHAMMER - FIBRE HANDLE



Code	Ref.		Icon	EAN
5117849	45130	3,00 kg	6	560248010208
5117850	45140	4,00 kg	4	560248012233
5117851	45150	5,00 kg	4	560248014183
5117852	451605	6,00 kg	2	560248018969

RIP CLAW HAMMER - FIBRE HANDLE



Code	Ref.		Icon	EAN
5109051	65306	600 g	6	5602482009745

CROSS PEIN HAMMER - FIBRE HANDLE



Code	Ref.			EAN
5109075	65216	16 mm	6	5602482007734
5109076	65218	18 mm	6	5602482008069
5109077	65220	20 mm	6	5602482008076
5109078	65222	22 mm	6	5602482009721
5109079	65225	25 mm	6	5602482009738

HATCHET/DIGGER PICKAXE - FIBRE HANDLE



Code	Ref.			EAN
5114930	85160	600 gr. 38 cm	6	5602482050051

FRENCH SHAPE JOINERS HAMMER - FIBRE HANDLE



Code	Ref.			EAN
5109073	35322	22 mm	6	5602482009752
5109074	35325	25 mm	6	5602482009769

HAMMER/DIGGER PICKAXE - FIBRE HANDLE



Code	Ref.			EAN
5114931	85260	600 gr. 38 cm	6	5602482050068

CLAW HAMMER - FIBRE HANDLE



Code	Ref.			EAN
5109041	15123	23 mm 510 gr.	6	5602482007123
5109042	15125	25 mm 645 gr.	6	5602482007130
5109043	15127	27 mm 730 gr.	6	5602482007147
5109044	15129	29 mm 840 gr.	6	5602482007666

PICKAXE - FIBRE HANDLE



Code	Ref.			EAN
5118803	85360	600 gr. 38 cm	6	5602482050075

PICKAXE - FIBRE HANDLE



Code	Ref.			EAN
5109053	85225	2,50 kg	6	5602482009837
5114469	84615H	2,50 kg oval	6	
5109054	85230	3,00 kg	6	5602482009844

FIBRE HANDLE (FOR HOES)



Code	Ref.			EAN
5110849	97712H	1.200 mm round	20	5602482029676

FIBRE SHAFT (FOR SLEDGEHAMMERS)



Code	Ref.			EAN
5110743	29-5	280 mm eye Ø 40x28 oval	100	5602482029774

FIBRE SHAFT (FOR SLEDGEHAMMERS)



Code	Ref.			EAN
5110747	45130H	900 mm eye Ø 48x37 oval	20	5602482029781

FIBRE HANDLE (FOR HAMMERS)



Code	Ref.			EAN
5110746	85150H	300 mm eye Ø 36x26 oval	100	5602482029798

FIBRE HANDLE (FOR HAMMERS)



Code	Ref.			EAN
5110744	15550H	330 mm eye Ø 30 round	100	5602482029804
5110745	95355H	370 mm eye Ø 30 round	100	5602482029811

FIBRE HANDLE (FOR PICKAXES)



Code	Ref.			EAN
5110748	85125H	900 mm eye Ø 47 round	20	5602482029828

BRICK HAMMER - WOOD HANDLE



Code	Ref.		EAN
5117843	600 g	4	5602482008137

RUBBER MALLET - WOOD HANDLE



Code	Ref.		EAN
5110112	16 oz. 4860 gr.	6	5602482025585
5110113	24 oz. 720 gr.	6	5602482025592
5110114	32 oz. 960 gr.	6	5602482025608

MASON'S MALLET - WOOD HANDLE



Code	Ref.		EAN
5110108	1.000 g	6	5602482025820

SLEDGE HAMMER - WOOD HANDLE



Code	Ref.		EAN
5109045	40108 800 gr.	12	560248009875
5109046	40110 1,000 gr.	12	560248009882
5109047	40125 1,250 gr.	12	560248009899
5109048	40115 1,500 gr.	12	560248009905

RUBBER MALLET - WOOD HANDLE



Code	Ref.		EAN
5110109	12 oz. 360 gr.	6	5602482025554
5110110	16 oz. 480 gr.	6	5602482025561

BALL-PEEN HAMMER - WOOD HANDLE



Code	Ref.		EAN
5118766	12 oz. 360 gr.	6	5602482025622
5118767	16 oz. 480 gr.	6	5602482025639
5118768	24 oz. 720 gr.	6	5602482025646
5118769	32 oz. 960 gr.	6	5602482025653
5118770	40 oz. 1.200 gr.	6	5602482025660

RIP CLAW HAMMER - WOOD HANDLE



Code	Ref.		EAN
5118771	700 gr.	6	5602482018976

CROSS PEIN HAMMER - WOOD HANDLE



Code	Ref.		EAN
5110093	16 mm	6	5602482025677
5110094	18 mm	6	5602482025684
5110095	20 mm	6	5602482025691
5110096	22 mm	6	5602482025707
5110097	25 mm	6	5602482025714

CLAW HAMMER - WOOD HANDLE



Code	Ref.		EAN
5110087	18 mm	6	5602482025721
5110088	21 mm	6	5602482025738
5110089	23 mm	6	5602482025745
5110090	25 mm	6	5602482025752
5110091	27 mm	6	5602482025769
5110092	29 mm	6	5602482025776

SLOTTED BITS - 25 mm



S2

Packaging with 20 pcs.

Code	Ref.			EAN
5116338	DS5737F25	4 mm	20	5602482057371
5116339	DS5738F25	5 mm	20	5602482057388
5116340	DS5739F25	6 mm	20	5602482057395

HEXAGONAL BITS - 25 mm



S2

Packaging with 20 pcs.

Code	Ref.			EAN
5116344	DS5743H25	H 3	20	5602482057432
5116345	DS5744H25	H 4	20	5602482057449
5116346	DS5745H25	H 5	20	5602482057456
5116347	DS5746H25	H 6	20	5602482057463

PHILIPS BITS - 25 mm



S2

Packaging with 20 pcs.

Code	Ref.			EAN
5116352	DS5751PH25	PH 0	20	5602482057517
5116353	DS5752PH25	PH 1	20	5602482057524
5116354	DS5753PH25	PH 2	20	5602482057531
5116355	DS5754PH25	PH 3	20	5602482057548

POZIDRIV BITS - 25 mm



S2

Packaging with 20 pcs.

Code	Ref.			EAN
5116360	DS5759PZ25	PZ 0	20	5602482057593
5116361	DS5760PZ25	PZ 1	20	5602482057609
5116362	DS5761PZ25	PZ 2	20	5602482057616
5116363	DS5762PZ25	PZ 3	20	5602482057623

SQUARE BITS - 25 mm



S2

Packaging with 20 pcs.

Code	Ref.			EAN
5116368	DS5788SQ25	SQ 0	20	5602482057883
5116369	DS5789SQ25	SQ 1	20	5602482057890
5116370	DS5790SQ25	SQ 2	20	5602482057906
5116371	DS5791SQ25	SQ 3	20	5602482057913

TORX BITS - 25 mm



S2

Packaging with 20 pcs.

Code	Ref.			EAN
5116376	DS5767T25	T-10	20	5602482057678
5116377	DS5768T25	T-15	20	5602482057685
5116378	DS5768T25	T-20	20	5602482057692
5116379	DS5770T25	T-25	20	5602482057708
5116380	DS5771T25	T-27	20	5602482057715
5115381	DS5772T25	T-30	20	5602482057722
5116382	DS5773T25	T-35	20	5602482057739
5116383	DS5774T25	T-40	20	5602482057746

XZN BITS - 25 mm



S2

Packaging with 20 pcs.

Code	Ref.			EAN
5116392	DS5796XZN25	M 5	20	5602482057968
5116393	DS5797XZN25	M 6	20	5602482057975
5116394	DS5798XZN25	M 8	20	5602482057982

XZN BITS - 30 mm



S2

Code	Ref.			EAN
5116395	DS5799XZN30	M10 30 mm	10	5602482057999
5116396	DS5800XZN30	M12 30 mm	10	5602482058002
5116397	DS5801XZN30	M14 30 mm	10	5602482058019

SLOTTED BITS - 50 mm



Packaging with 10 pcs.

S2

Code	Ref.			EAN
5116341	DS5740F50	4 mm	10	5602482057401
5116342	DS5741F50	5 mm	10	5602482057418
5115343	DS5742F50	6 mm	10	5602482057425

HEXAGONAL BITS - 50 mm



Packaging with 10 pcs.

S2

Code	Ref.			EAN
5116348	DS5747H50	H 3	10	5602482057470
5116349	DS5748H50	H 4	10	5602482057487
5116350	DS5749H50	H 5	10	5602482057494
5116351	DS5750H50	H 6	10	5602482057500

PHILIPS BITS - 50 mm



Packaging with 10 pcs.

S2

Code	Ref.			EAN
5116356	DS5755PH50	PH 0	10	5602482057555
5116357	DS5756PH50	PH 1	10	5602482057562
5116358	DS5757PH50	PH 2	10	5602482057579
5116359	DS5758PH50	PH 3	10	5602482057586

POZIDRIV BITS - 50 mm



Packaging with 10 pcs.

S2

Code	Ref.			EAN
5116364	DS5763PZ50	PZ 0	10	5602482057630
5116365	DS5764PZ50	PZ 1	10	5602482057647
5116366	DS5765PZ50	PZ 2	10	5602482057654
5116367	DS5766PZ50	PZ 3	10	5602482057661

SQUARE BITS - 50 mm



Packaging with 10 pcs.

S2

Code	Ref.			EAN
5116372	DS5792SQ50	SQ 0	10	5602482057920
51163783	DS5793SQ50	SQ 1	10	5602482057937
5116374	DS5794SQ50	SQ 2	10	5602482057944
5116375	DS5795SQ50	SQ 3	10	5602482057951

TORX BITS - 50 mm



Packaging with 20 pcs.

S2

Code	Ref.			EAN
5116384	DS5775T50	T-10	20	5602482057753
5116385	DS5776T50	T-15	20	5602482057760
5116386	DS5777T50	T-20	20	5602482057777
5116387	DS5778T50	T-25	20	5602482057784
5116388	DS5779T50	T-27	20	5602482057791
5116389	DS5780T50	T-30	20	5602482057807
5116390	DS5781T50	T-35	20	5602482057814
5116391	DS5782T50	T-40	20	5602482057821

XZN BITS - 50 mm



Packaging with 10, 5 and 3 pcs.

S2

Code	Ref.			EAN
5116398	DS5802XZN50	M 5	10	5602482058026
5116399	DS5803XZN50	M 6	10	5602482058033
5116400	DS5804XZN50	M 8	10	5602482058040
5116401	DS5805XZN50	M 10	5	5602482058057
5116402	DS5806XZN50	M 12	5	5602482058064
5116403	DS5807XZN50	M14	3	5602482058071

SOCKET ADAPTOR SET



CR-V

Code	Ref.		EAN
5116409	DS57833	1/4" - 3/8" - 1/2"	5602482057838

EXTRACTOR



Code	Ref.		EAN
5116410	DS5784EXT5	5 pcs	5602482057845

IMPACT EXTRACTOR

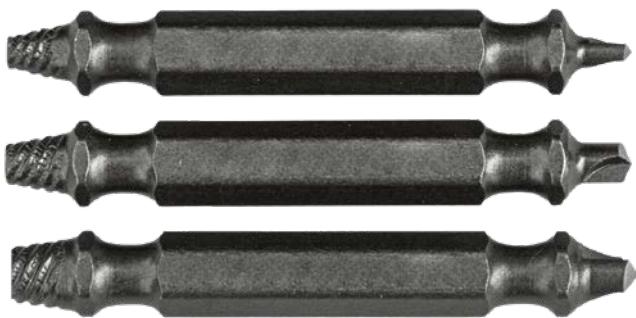

Code	Ref.		EAN
5116411	DS5785EXT3	3 pcs	5602482057852

BITS



S2

- Composition:**
- Slotted: 3; 2x5; 6 mm
 - ⊕ Philips: 2xPH1; 4xPH2; 2xPH3
 - ⊕ Pozidriv: PZ1; PZ2; PZ3
 - ⊕ Hexagonal: H3; 2xH4; 2xH5; H6
 - ⊕ Torx: T10, T15, T20, T25; T30; T-30; T40
 - ⊕ Square: S1; S2; S3
 - Magnetic bit holder 60mm
 - Adapter 1/4"

Code	Ref.		EAN
5116404	DS5786	33 pcs.	5602482057869

MAGNETIC BIT HOLDER



Code	Ref.		EAN
5116412	DS5787	60 mm	5602482057876

INSULATED ELECTRICIAN SCREWDRIVER



Code	Ref.			EAN
5114673	3021/11	3,5 x 100 mm	12	5602482027046
5114674	3021/12	5,5 x 125 mm	12	5602482027053
5114675	3021/13	6,5 x 150 mm	12	5602482027060

INSULATED PHILLIPS SCREWDRIVER



Code	Ref.			EAN
5114682	3021/21	0 x 60 mm	12	5602482027145
5114683	3021/22	1 x 80 mm	12	5602482027152
5114684	3021/23	2 x 100 mm	12	5602482027169

LONG REACH FLAT SCREWDRIVER



Code	Ref.			EAN
5114670	3021/8	3,0 x 200 mm	12	5602482027015
5114671	3021/9	4,0 x 250 mm	12	5602482027022
5114672	3021/10	5,5 x 300 mm	12	5602482027039

LONG REACH PHILLIPS SCREWDRIVER



Code	Ref.			EAN
5114680	3021/19	1 x 250 mm	12	5602482027121
5114681	3021/20	2 x 300 mm	12	5602482027138

FLAT HEAD SCREWDRIVER



Code	Ref.			EAN
5114665	3021/1	3,5 x 75 mm	12	5602482026940
5114666	3021/2	5 x 100 mm	12	5602482026957
5114667	3021/3	6 x 125 mm	12	5602482026964
5114668	3021/4	7 x 150 mm	12	5602482026971
5114669	3021/5	8 x 175 mm	12	5602482026988

PHILLIPS SCREWDRIVER



Code	Ref.			EAN
5114676	3021/14	0 x 75 mm	12	5602482027077
5114677	3021/15	1 x 100 mm	12	5602482027084
5114678	3021/16	2 x 125 mm	12	5602482027091
5114679	3021/17	3 x 150 mm	12	5602482027107

POZIDRIV SCREWDRIVER



Code	Ref.			EAN
5114685	3021/24	0 x 100 mm	12	5602482027176
5114686	3021/25	1 x 80 mm	12	5602482027183
5114687	3021/26	2 x 100 mm	12	5602482027190
5114688	3021/27	3 x 150 mm	12	5602482027206

ELECTRICIAN SCREWDRIVER SET



Contents
 4 electrician screwdrivers: 2,5x75 mm | 3,5x100 mm | 5,5x125 mm | 6,5x150 mm
 2 phillips screwdrivers: PH1x10 mm | PH2x100 mm
 1 mains tester: 140 mm

Code	Ref.			EAN
5114690	DS2721	7 pieces		5602482027213

SCREWDRIVER SET



Contents
 4 screwdrivers: 2,5x75 mm | 3,5x100 mm | 5,5x125 mm | 6,5x150 mm
 3 phillips screwdrivers: PH0x75 mm | PH1x100 mm | PH2x125 mm

Code	Ref.			EAN
5114689	DS2720	7 pieces		5602482027220

HEXAGON KEY SET



Size: 2,5/ 3/ 4/ 5/ 6/ 8/ 10 mm

Code	Ref.			EAN
5106438	5072F		10	5602482001435

TORX KEY SET



Size: T9/ T10/ T15/ T20/ T25/ T27/ T30/ T40

Code	Ref.			EAN
5106450	5083TF	pierced	10	5602482020214

PROFESSIONAL STAPLE GUN



Chrome plated stapler with quick release button, ideal for all types of fabrics/textiles or thin wooden profiles. Powerful and high efficiency. Impact power adjustment.

Code	Ref.	for staples		EAN
5116330	DS5810YJ009	4 a 14 mm		5602482058101

4 IN 1 STAPLE GUN



Professional 4 in 1 heavy duty stapler. Suitable for insulation, house cladding, roofing, cabling, carpets, upholstery. Uses heavy duty, light duty and cable staples as well as nails up to 15mm.

Code	Ref.	for staples		EAN
5116332	DS5808YJ120	6 a 14 mm		5602482058088

STAPLE GUN



Metal stapler, painted for medium duty work. Ideal for a wide range of applications, stapler can staple some of the most difficult surfaces. Lightweight, compact and highly efficient. Safety lock.

Code	Ref.	for staples		EAN
5116331	DS5809YJ105	6 a 10 mm		5602482058095

STAPLES



Code	Ref.	for staples		EAN
5116333	DS5811YJ	10 mm (box 1.000)		5602482058118
5116334	DS5812YJ	12 mm (box 1.000)		5602482058125
5116335	DS5813YJ	14 mm (box 1.000)		5602482058132

FIXED BLADE TRIMMING KNIFE



Code	Ref.		EAN
5109731	SX-75	19 X 61 mm	5602482012585

BLADE FOR TRIMMING KNIFE



Code	Ref.		EAN
5109732	SX-11N	19 x 61 mm	5602482014435

PLASTIC WINDOW SCRAPER

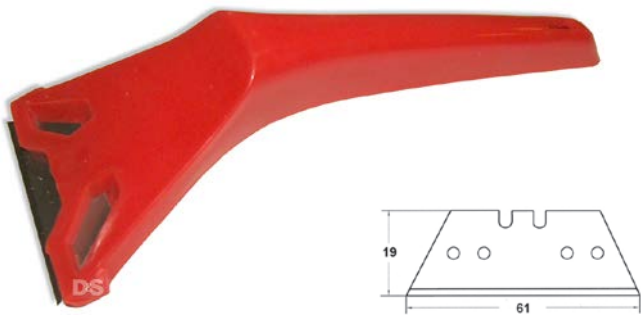

Code	Ref.		EAN
5109733	SX-53-1	19 x 61 mm	5602482012592

PLASTIC RETRACTABLE KNIFE

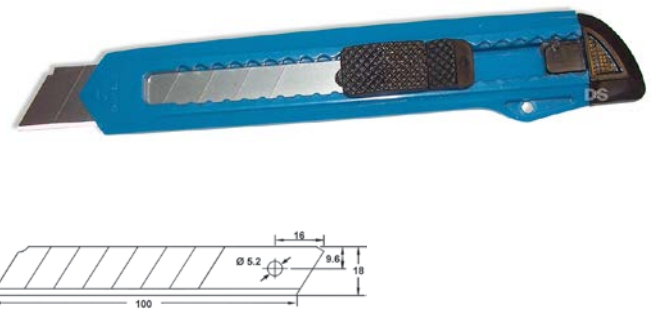

Code	Ref.		EAN
5109738	SX-10	18 x 100 mm	5602482013452

METALLIC WINDOW SCRAPER



Code	Ref.		EAN
5110801	SX-802	14 x 100 mm	5602482029910

PLASTIC RETRACTABLE KNIFE

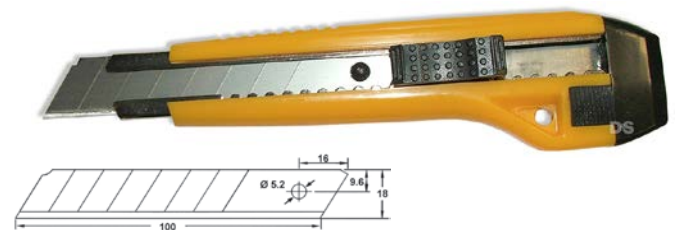

Code	Ref.		EAN
5110803	SX-45	18 x 100 mm	5602482029934

SPARE BLADES FOR SCRAPERS



Code	Ref.		EAN
5110802	SX-802T	14 x 100 mm	5602482029927

METALLIC RETRACTABLE KNIFE

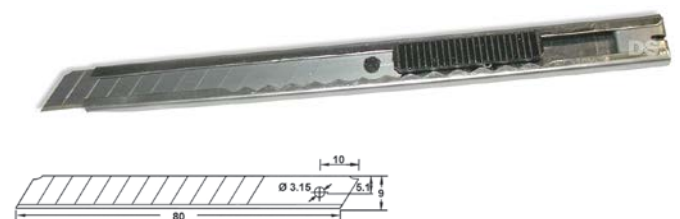

Code	Ref.		EAN
5110804	SX-48A	9 x 80 mm	5602482012912

PLASTIC/RUBBER RETRACTABLE KNIFE

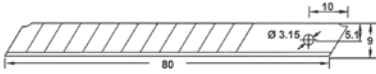

Code	Ref.		EAN
5109725	SX-71-1	9 x 80 mm	5602482028463

PLASTIC/RUBBER RETRACTABLE KNIFE

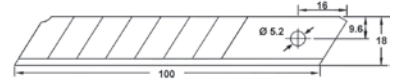

Code	Ref.		EAN
5109724	SX-1800	18 x 100 mm	5602482021631

METALLIC RETRACTABLE KNIFE

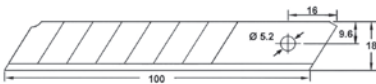

Code	Ref.		EAN
5109729	SX-78	18 x 100 mm	5602482012530

PLASTIC/RUBBER RETRACTABLE KNIFE

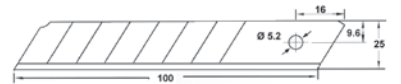

Code	Ref.		EAN
5109739	SX-2900	25 x 100 mm	5602482025073

METALLIC RETRACTABLE KNIFE

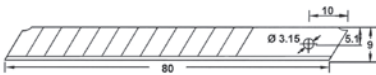

Code	Ref.		EAN
5109730	SX-78-1	9 x 80 mm	5602482012547

SPARE RETRACTABLE KNIFE BLADES

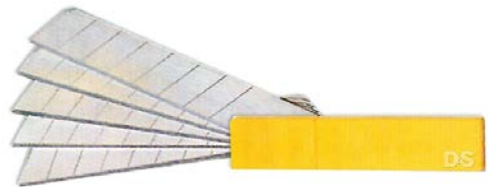

Code	Ref.		EAN
5109736	SX- 9T	9 x 80 mm	5602482013353
5109735	SX-18T	18 x 100 mm	5602482012929
5109737	SX-25T	25 x 100 mm	5602482013421

PLASTIC/RUBBER RETRACTABLE KNIFE

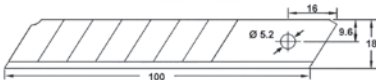

Code	Ref.		EAN
5109723	SX-83	18 x 100 mm	5602482021624

SPARE RETRACTABLE KNIFE BLADES



Code	Ref.		EAN
1108129	9AV	9 x 80 mm (10)	5600358470569
1108128	18AV	18 x 100 mm (10)	5600358470538

METALLIC RETRACTABLE KNIFE



Code	Ref.		EAN
1108185	DS4739	18 x 100 mm	5602482047396

PLASTIC RETRACTABLE KNIFE

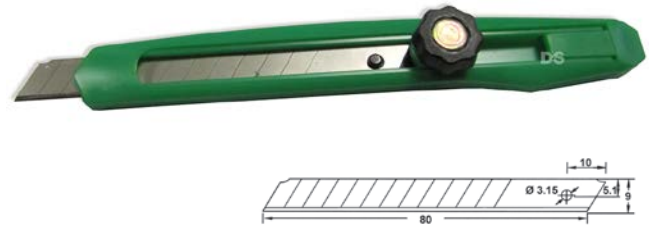

Code	Ref.		EAN
1108123	K-250	9 x 80 mm	8013798000048

PLASTIC RETRACTABLE KNIFE (DISPLAY BOX OF 36)



Contents
 4 K700 knives
 8 K400 knives
 12 K300 knives
 12 K250 knives

Code	Ref.		EAN
1108126	XAT9	9 x 80 mm	5602482046320

PLASTIC RETRACTABLE KNIFE

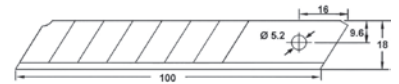

Code	Ref.		EAN
1108125	K-6000	18 x 100 mm	5602482046313

PLASTIC RETRACTABLE KNIFE (DISPLAY BOX OF 24)



Contents
 12 K500 knives
 12 K600 knives

Code	Ref.		EAN
1108127	XAT18	18 x 100 mm	5602482046337

FOAM GUN



Code	Ref.		EAN
5112251	GH-PU001B	12	5602482041981

CAULKING GUN



Code	Ref.		EAN
5104304	ZP9	40	5602482020504

CAULKING GUN



Code	Ref.		EAN
5104305	20022	24	5602482020511

CAULKING GUN



* with metal rings and plastic nozzles

Code	Ref.		EAN
5110805	GH3036A	12	5602482030466

CAULKING GUN



Code	Ref.		EAN
5104849	3028	12	5602482021648

CAULKING GUN



Code	Ref.		EAN
5110800	GH3042A	12	5602482030459

CRIMPED WIRE WHEEL BRUSHES



Technical Information

They are designed for individual tasks with wide possibilities in dimensions, arbor holes and wires.

Applications

Removal of rust, paint, scale, edges, etc. Cleaning of forged pieces. Tyre recovery. Surface processing in metal, rubber, plastic, wood, glass, etc.

Code	Ref.		EAN
5116040	DS5202	100 mm 6.500 r.p.m.	5602482052024
5116041	DS5203	125 mm 6.500 r.p.m.	5602482052031
5116042	DS5204	150 mm 6.500 r.p.m.	5602482052048
5116043	DS5205	175 mm 6.500 r.p.m.	5602482052055
5116044	DS5206	200 mm 4.500 r.p.m.	5602482052062

CRIMPED WIRE CUP BRUSHES



Technical Information:

Specially designed for use on portable machines (angle grinders), electric or pneumatic.

Applications:

Removal of rust, paint or any kind of adherence. Cleaning of castings. Treating metallic surfaces, rubber, plastic, wood or glass. Metallic construction, ship-building, boiler industry, stone and concrete..

Code	Ref.		EAN
5116052	DS5197	M14 x 75 mm 12.500 r.p.m.	5602482051973
5116053	DS5198	M14 x 100 mm 8.500 r.p.m.	5602482051980
5116054	DS5199	M14 x 125 mm 8.500 r.p.m.	5602482051997
5116055	DS5200	M14 x 150 mm 6.000 r.p.m.	5602482052000

CRIMPED WIRE BRUSHES



Technical Information

Special design allowing access to angles and flexible performance on any surface. Specially designed for low weight and high speed mini-grinders.

Applications:

For continuous and frequent brushing processes (ship building, metallic structures, welding, maintenance, etc.).

Code	Ref.		EAN
5116048	DS5201	M14 x 100 mm 13.000 r.p.m.	5602482052017

UNIVERSAL HAND BRUSH



Technical Information

Special design offering:

- Long working life.
- Maximum removal capacity.

High wire density for a higher brushing pressure. Narrow face to allow easy access into slots .

Applications

Welding: cleaning and scale removal. Removal of rust, paint and any kind of adherence. Appropriate for household and DIY due to its universal and comfortable use.

Code	Ref.		EAN
5116056	DS5211	Stainless stell	12 5602482052116
5116057	DS5212	Steel	12 5602482052123

CATRABUCHA PINCEL (ARAME ONDULADO)

CEPILLO BROCHA (ALAMBRE ONDULADO)



Applications:

Removal of rust, paint and any kind of adherence in gates, balconies, cars, etc.
 Preparing surfaces for painting.
 Polishing of metallic pieces.
 Working on wooden rustic pieces.

Code	Ref.		EAN
5116049	DS5190	25 mm 4.500 r.p.m.	5602482051904

CATRABUCHA T/TAÇA (ARAME ONDULADO)

CEPILLO T/TAZA (ALAMBRE ONDULADO)



Applications:

Removal of rust, paint and any kind of adherence in gates, balconies, cars, etc.
 Preparing surfaces for painting.
 Polishing of metallic pieces.
 Working on wooden rustic pieces.

Code	Ref.		EAN
5116050	DS5194	50 mm 4.500 r.p.m.	5602482051942
5116051	DS5195	75 mm 4.500 r.p.m.	5602482051959

CATRABUCHA CIRCULAR (ARAME ONDULADO)

CEPILLO CIRCULAR (ALAMBRE ONDULADO)



Applications:

Removal of rust, paint and any kind of adherence in gates, balconies, cars, etc.
 Preparing surfaces for painting.
 Polishing of metallic pieces.
 Working on wooden rustic pieces.

Code	Ref.		EAN
5116045	DS5191	50 mm 4.500 r.p.m.	5602482051911
5116046	DS5192	75 mm 4.500 r.p.m.	5602482051928
5116047	DS5193	100 mm 4.500 r.p.m.	5602482051935

CATRABUCHA CIRCULAR (ARAME ONDULADO)

CEPILLO CIRCULAR (ALAMBRE ONDULADO)



Applications:

Removal of rust, paint and any kind of adherence in gates, balconies, cars, etc.
 Preparing surfaces for painting.
 Polishing of metallic pieces.
 Working on wooden rustic pieces.

Code	Ref.		EAN
5116039	DS5196	75 mm 4.500 r.p.m.	5602482051966

WIRE BRUSHES



Knotted cup brush to work with right angle grinders. For heavy removal of rust, paint and other type of adhesives

Applications:

Removal of rust, paint, scales, edges, etc. Cleaning of forged pieces.
Tyre recovery. Surface processing in metal, rubber, plastic, wood, glass, etc.

Code	Ref.		EAN
5116037	DS5209	M14 x 80 mm 8.500 r.p.m.	5602482052093
5116038	DS5210	M14 x 100 mm 8.500 r.p.m.	5602482052109

WIRE BRUSHES



Knotted cup brush to work with right angle grinders. For heavy removal of rust, paint and other type of adhesives

Applications:

Removal of rust, paint, scales, edges, etc. Cleaning of forged pieces.
Tyre recovery. Surface processing in metal, rubber, plastic, wood, glass, etc.

Code	Ref.		EAN
5116035	DS5207	M14 x 65 mm 12.500 r.p.m.	5602482052079
5116036	DS5208	M14 x 100 mm 12.500 r.p.m.	5602482052086

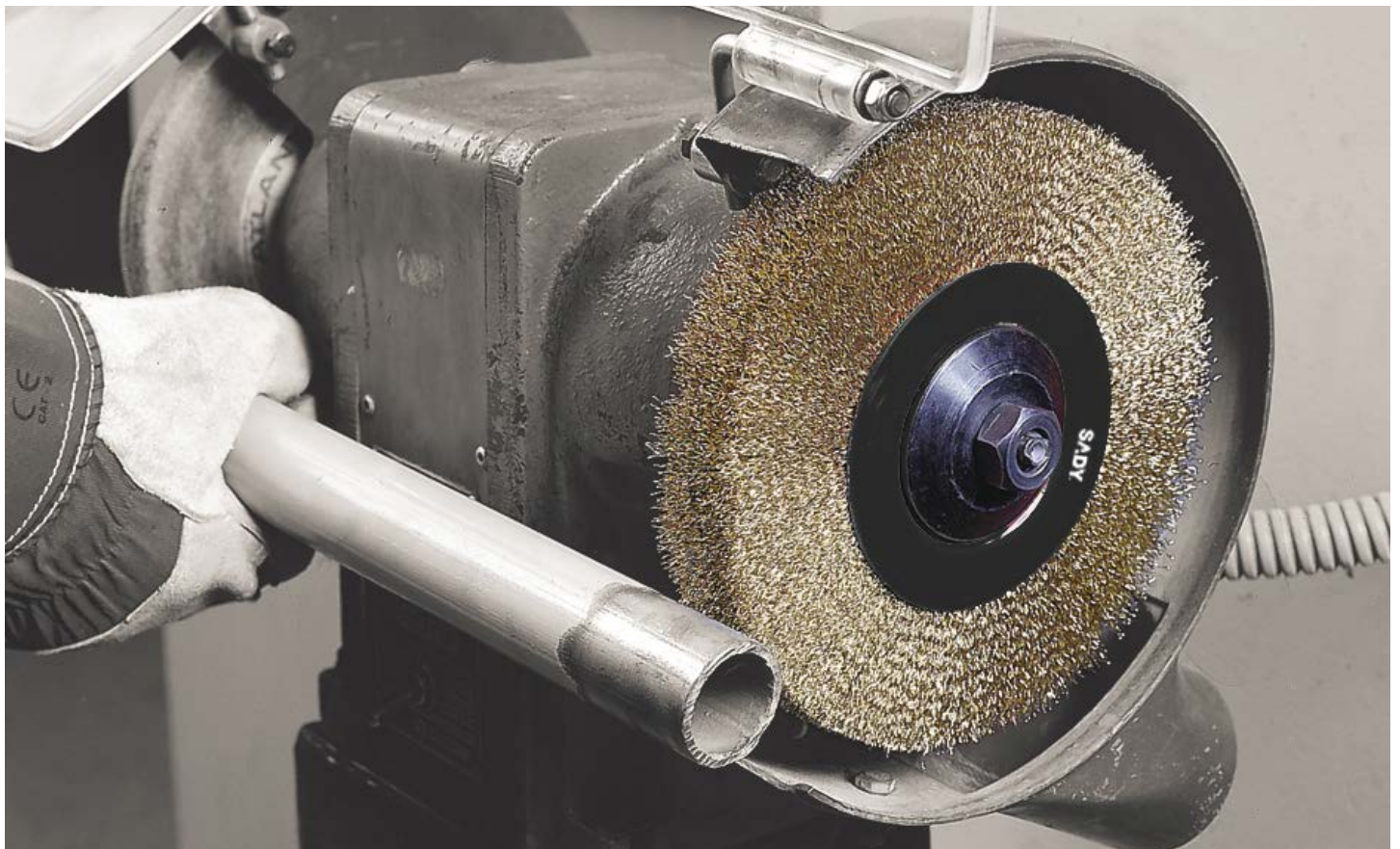

BENCH VICE

QUICK ADJUSTING VICE

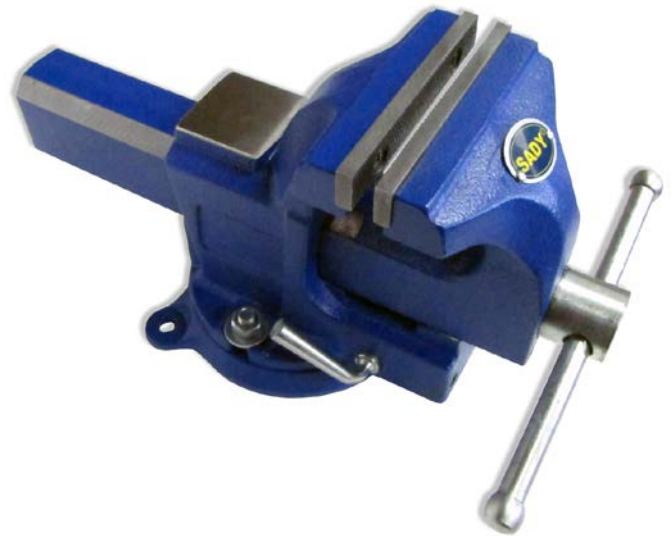

Code	Ref.		EAN
5113799	88303	75 mm	5602482045859
5113800	83304	100 mm	5602482045866
5113801	83305	125 mm	5602482045873
5113802	83306	150 mm	5602482045880

Code	Ref.		EAN
5113807	1404	100 mm	5602482045897
5113808	1405	125 mm	5602482045903

BENCH VICE



Code	Ref.		EAN
5113803	83103	75 mm	5602482045811
5113804	83104	100 mm	5602482045828
5113805	83105	125 mm	5602482045835
5113806	83106	150 mm	5602482045842

METAL CUTTING DISC



Abrasive discs reinforced with depressed centre. Appropriate for angle grinders.
Applications: Woodwork, metalwork, metal profiles, pipes ...

Code	Ref.		EAN
5101336	115 x 3,2 x 22,2	25	5602482024786
5101341	125 x 3,2 x 22,2	25	5602482024793
5101334	180 x 3,2 x 22,2	25	5602482024809
5101335	230 x 3,2 x 22,2	25	5602482024816

STAINLESS STEEL CUTTING DISC



Cutting discs.
For special applications.

Code	Ref.		EAN
5101350	115 x 1,0 x 22,2	50	5602482024861
5101351	125 x 1,0 x 22,2	50	5602482024878
5101352	180 x 1,6 x 22,2	25	5602482024885
5100955	230 x 1,9 x 22,2	25	5602482025882

FLAT METAL CUTTING DISC



Cutting discs.
For special applications.

Code	Ref.		EAN
5101353	115 x 1,6 x 22,2	50	5602482024892

METAL GRINDING DISC



Abrasive discs reinforced for the grinding of iron and steel. Appropriate for angle grinders.
Applications: woodwork, metalwork, welding, casting burr ...

Code	Ref.		EAN
5101348	115 x 6,4 x 22,2	10	5602482024915
5101349	125 x 6,4 x 22,2	10	5602482024922
5101346	180 x 6,4 x 22,2	10	5602482024939
5101347	230 x 6,4 x 22,2	10	5602482024946

STONE CUTTING DISC



Stone cutting discs - Abrasive discs, reinforced for cutting marble, stones and building materials. Appropriate for angle grinders.

Code	Ref.		EAN
5101344	115 x 3,2 x 22,2	25	5602482024823
5101343	230 x 3,2 x 22,2	25	5602482024854

FLAT STONE CUTTING DISC



Cutting discs. For special applications.

Code	Ref.		EAN
5101354	115 x 1,6 x 22,2	50	5602482024908

POLYCARBIDE ABRASIVE DISC (WITH SCREW)



Appropriate for angle grinders. Perfect for removing rust, varnish, welding finish ... Cleans the surfaces without damaging them.

Code	Ref.		EAN
5114585	DS4702 125 x 13 mm		5602482047020

POLYCARBIDE ABRASIVE DISC (FOR ANGLE GRINDERS)



Appropriate for angle grinders. Perfect for removing rust, varnish, welding finish ... Cleans the surfaces without damaging them.

Code	Ref.		EAN
5114586	DS4703 115 x 22.2 mm	5	5602482047037

RUBBER BACKING PAD



Code	Ref.		EAN
5110130	DPM2678 for 115 mm angle grinders	20	5602482026780
5110131	DPM2679 for 180 mm angle grinders	15	5602482026797

DIAMOND CUTTING DISC | CONTINUOUS RIM



7
mm

Cutting of natural and artificial stones, concrete, ceramic materials, building materials.
Segment height: 7 mm
 According to EN 13236

Code	Ref.			EAN
5100964	DS2508	115 x 22,2 mm	100	5602482025080
5110866	DS3051	125 x 22,2 mm	100	5602482030510
5110867	DS3052	180 x 22,2 mm	50	5602482030527
5100975	DS2509	230 x 22,2 mm	25	5602482025097

DIAMOND CUTTING DISC | CONTINUOUS RIM



10
mm

Cutting of natural and artificial stones, concrete, ceramic materials, building materials.
Segment height: 10 mm
 According to EN 13236

Code	Ref.		EAN
5111513	DS4126	115 x 22,2 mm	5602482041264
5111514	DS4127	230 x 22,2 mm	5602482041271

DIAMOND CUTTING DISC | SEGMENTED RIM



7
mm

Cutting of natural and artificial stones, concrete, ceramic materials, building materials.
Segment height: 7 mm
 According to EN 13236

Code	Ref.		EAN
5100962	DS2510	115 x 22,2 mm	5602482025103
5110864	DS3049	125 x 22,2 mm	5602482030497
5110865	DS3050	180 x 22,2 mm	5602482030503
5100963	DS2511	230 x 22,2 mm	5602482025110

DIAMOND CUTTING DISC | SEGMENTED RIM



10
mm

Cutting of natural and artificial stones, concrete, ceramic materials, building materials.
Segment height: 10 mm
 According to EN 13236

Code	Ref.		EAN
5111511	DS4124	115 x 22,2 mm	5602482041240
5111512	DS4125	230 x 22,2 mm	5602482041257

DIAMOND DISC - SUPER THIN



Cutting of natural and artificial stones, concrete, ceramic materials, building materials. According to EN 13236

Code	Ref.		EAN
5110854	DS3014	115 x 1,2 x 22,2 mm	5602482030145

DIAMOND DISC - MULTI-PURPOSE



Will cut plastic profiles and pipes, wood (even with nails), fibreglass, concrete, metal, ...

Code	Ref.		EAN
5112899	27500115	115 x 5 x 22,2 mm	5602482043077
5112900	27500230	230 x 5 x 22,2 mm	5602482043084

DIAMOND DISC - MARBLE



Conceived for cutting marble.

Code	Ref.		EAN
5100960	DS2532	115 x 2,2 x 22,2 mm	5602482025325
5100961	DS2533	230 x 2,2 x 22,2 mm	5602482025332

DIAMOND DISC - TURBO MESH



Suitable for cutting ceramic, porcelain, vitrified tile, granite, stoneware, hard tile and so on stone materials.

Code	Ref.		EAN
5114983	30410115	115x1,2x10x22,23 mm	5602482050563
5114984	30410125	125x1,2x10x22,23 mm	5602482050570
5114985	30410230	230x1,2x10x22,23 mm	5602482050587

DIAMOND CUTTING DISC | CONTINUOUS RIM



Cutting of natural and artificial stones, concrete, ceramic materials, building materials.
For Sady tile cutting machine **DS5278-TSW230**

Code	Ref.			EAN
5116090	DS4989	230 x 2,4 x 25,4 mm	25	5602482049895

SWIRLING SEGMENT DIAMOND CUP WHEEL

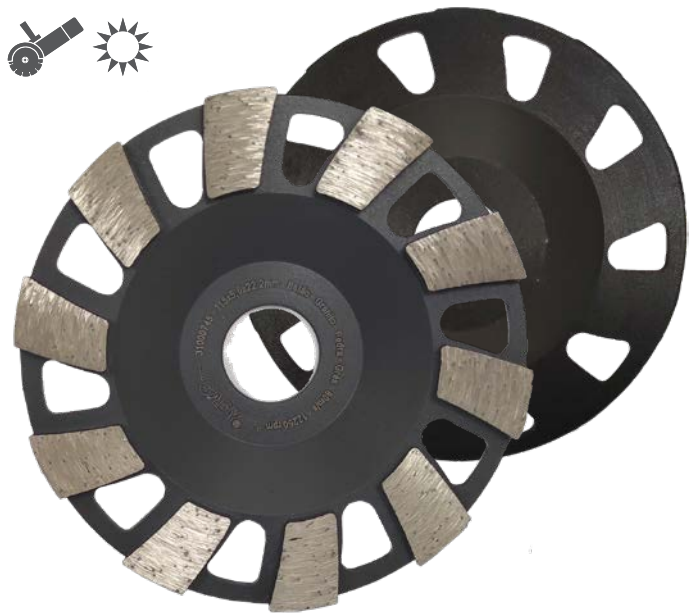
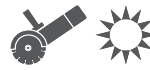

For the smoothing and levelling of concrete and exposed concrete surfaces, granite, stone, ...
Plaquette: Width: 15 mm | Height: 5 mm

Code	Ref.			EAN
5114986	31000745	115 x 22,23 mm		5602482050679
	31000705	125 x 22,23 mm		5602482050686
5114987	31000707	180 x 11,23 mm		5602482050693

DIAMOND CUP GRINDING WHEEL



For the smoothing and levelling of concrete and exposed concrete surfaces, granite, stone, ...
Plaquette: Width: 8 mm | Height: 5 mm

Code	Ref.			EAN
5112901	31000345	115 x 22,23 mm		5602482043091
5114977	31000305	125 x 22,23 mm		5602482050655
5114978	31000307	180 x 11,23 mm		5602482050662

ARROWED TURBO DIAMOND CUP WHEEL



For the smoothing and levelling of concrete and exposed concrete surfaces, granite, stone, ...
Plaquette: Height: 5 mm

Code	Ref.			EAN
5114989	31000145	115 x 22,23 mm		5602482050709
5114988	31000105	125 x 22,23 mm		5602482050716
	31010107	180 x 11,23 mm		5602482050723

FLAP DISC FOR STAINLESS STEEL

SANDING DISC



Tipo Z Type Z - Discs with zirconia material for stainless steel, special steel and plastic. Flat contact surface. Support made of nylon fibre.

Code	Ref.		EAN
5101355	grit 40 115 x 22,2	5	5602482024953
5101356	grit 60 115 x 22,2	5	5602482024960
5101357	grit 80 115 x 22,2	5	5602482024977
5100956	grit 100 115 x 22,2	5	5602482025349
5100957	grit 120 115 x 22,2	5	5602482025356

Code	Ref.		EAN
5101362	Ø 115 grit 16	25	5602482030725
5101364	Ø 115 grit 24	25	5602482030541
5101366	Ø 115 / grit 36	25	5602482030565
5101367	Ø 115 / grit 40	25	5602482030572
5101368	Ø 115 / grit 50	25	5602482030589
5101372	Ø 115 / grit 60	25	5602482030596
5101373	Ø 115 / grit 80	25	5602482030602
5101374	Ø 115 / grit 100	25	5602482030619
5101375	Ø 115 / grit 120	25	5602482030626
5117992	Ø 125 / grit 16	25	5602482037502
5117993	Ø 125 / grit 20	25	5602482037519
5117994	Ø 125 / grit 24	25	5602482037526
5117996	Ø 125 / grit 36	25	5602482037540
5117997	Ø 125 / grit 40	25	5602482037557
5117999	Ø 125 / grit 60	25	5602482037571
5118000	Ø 125 / grit 80	25	5602482037588
5118001	Ø 125 / grit 100	25	5602482037595
5118002	Ø 125 / grit 120	25	5602482037601
5103694	Ø 180 / grit 20	25	5602482041998
5101377	Ø 180 / grit 30	25	5602482030640
5101378	Ø 180 / grit 36	25	5602482030657
5101379	Ø 180 / grit 40	25	5602482030664
5101381	Ø 180 / grit 60	25	5602482030688
5101382	Ø 180 / grit 80	25	5602482030695
5101383	Ø 180 / grit 100	25	5602482030701
5101384	Ø 180 / grit 120	25	5602482030718

FLAP DISC FOR METAL



Type A - Regular aluminium oxide discs for ferrous metals. Flat contact surface. Support made of nylon fibre.

Code	Ref.		EAN
5101358	grit 40 115 x 22,2	5	5602482024984
5101359	grit 60 115 x 22,2	5	5602482024991
5101360	grit 80 115 x 22,2	5	5602482025004
5100958	grit 100 115 x 22,2	5	5602482025868
5100959	grit 120 115 x 22,2	5	5602482025875

SANDING DISC

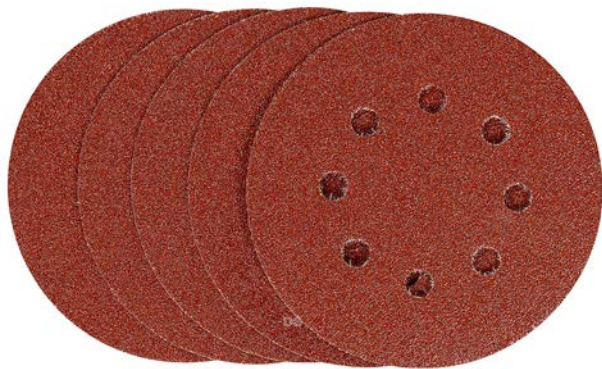

Code	Ref.			EAN
5114639	1919	125 mm grit 60	25	5602482048942
5114638	1919	125 mm grit 80	25	5602482048959
5114636	1919	125 mm grit 100	25	5602482048966
5114637	1919	125 mm grit 120	25	5602482048973

CUP WHEEL STONE



Features - Agglomerated product made of silicon carbide and aluminium oxide.
Usage - Grinding, polishing and finishing.
Applications - High performance in marble and construction.

Code	Ref.			EAN
5110120		grit 16 100 x 54 M14	27	5602482026803
5110122		grit 24 100 x 54 M14	27	5602482026827
5110124		grit 36 100 x 54 M14	27	5602482026841
5110125		grit 40 100 x 54 M14	27	5602482026858
5110126		grit 80 100 x 54 M14	27	5602482026865
5110127		grit 60 100 x 54 M14	27	5602482026872
5110128		grit 100 100 x 54 M14	27	5602482026889
5110129		grit 120 100 x 54 M14	27	5602482026896

SANDING DISC FOR DRYWALL SANDER



Code	Ref.			EAN
5114779	DS510	Ø 225 mm Grão 80	25	5602482050297
5114780	DS510	Ø 225 mm Grão 120	25	5602482050303
5114781	DS510	Ø 225 mm Grão 240	25	5602482050310

RUBBER BACKING PAD



Code	Ref.			EAN
5114888	DPM5134	para rebarbadoras 115 mm		5602482051348

VOLTAGE TESTER



Code	Ref.		EAN
5116066	DS5275	140 mm	5602482052758

VOLTAGE TESTER



Code	Ref.		EAN
5116067	DS5276	190 mm	5602482052765

DIGITAL VOLTIMETER



- AC voltage: 2V/ 20V/ 200V/ 600V
- DC voltage: 200mV/ 2V/ 20V/ 200V/ 600V
- DC current: 200µA/ 2000µA/ 20mA/ 200mA/ 2A/ 10A
- Resistance: 200 Ω/ 2kΩ/ 20kΩ/ 200 kΩ/ 2MΩ/ 20MΩ
- Detector NCV

Code	Ref.		EAN
5116069	DS5274		5602482052741

VOLTAGE TESTER



Code	Ref.		EAN
5116068	DS5277	Ø 2 x 115 mm	5602482052772

PVC TAPE



- Applications:** PVC tape with excellent flexibility and adhesion at low temperatures.
- For insulation of wires and cables, marking, bundling, repairing.
- Characteristics:**
- Product certified according to DEKRA.
 - Safe protection up to 7000V

Code	Ref.	20 met. x 19 mm		EAN
5511673	DS51225	yellow/green	10	5602482051256
5511674	DS51226	yellow	10	5602482051263
5511675	DS51227	blue	10	5602482051270
5511676	DS51228	white	10	5602482051287
5511677	DS51229	brown	10	5602482051294
5511678	DS51230	grey	10	5602482051300
5511679	DS51231	black	10	5602482051317
5511680	DS51232	green	10	5602482051324
5511681	DS51233	red	10	5602482051331

MEASURING TAPE FIBERGLASS

fibreglass

ABS open box with high resistance. Bimaterial handle and ergonomic design



Code	Ref.		EAN
5118784	DS5338-19B	50 met. x 15 mm	6 5602482053380

MEASURING TAPE FIBERGLASS | EL

fibreglass

ABS case, rubber coated. Fibreglass strap. Plastic crank.



Code	Ref.		EAN
5118785	DS5339-EL	20 met. x 15 mm	6 5602482053397
5118786	DS5340-EL	30 met. x 15 mm	5602482053403

MEASURING TAPE FIBERGLASS | HY

fibreglass

Plastic case. Fibreglass strap. Metallic crank.



Code	Ref.		EAN
5118789	DS5343-HY	10 met. x 13 mm	6 5602482053434
5118790	DS5344-HY	20 met. x 13 mm	6 5602482053441
5118791	DS5345-HY	30 met. x 16 mm	6 5602482053458

MEASURING TAPE STEEL | GL

steel

ABS case, rubber coated. White steel band. Plastic crank.



Code	Ref.		EAN
5118787	DS5341-GL	20 met. x 13 mm	6 5602482053410
5118788	DS5342-GL	30 met. x 13 mm	5602482053427

MEASURING TAPE ABS CASE | RX



Steel strap with nylon coating. ABS case with rubber coating. Locking button and automatic retraction. Metal hook.

Code	Ref.		EAN
5118792	DS5346-RX	3 met. x 16 mm	6 5602482053465
5118793	DS5347-RX	5 met. x 19 mm	6 5602482053472
5118794	DS5348-RX	5 met. x 25 mm	6 5602482053489
5118795	DS5349-RX	8 met. x 25 mm	6 5602482053496

MEASURING TAPE | XTS



Steel strap with nylon coating. ABS box. Locking button and automatic retraction. Metal hook.

Code	Ref.		EAN
5118796	DS5353-XTS	3 met. x 16 mm	12 5602482053502
5118797	DS5351-XTS	5 met. x 19 mm	12 5602482053519

4 IN 1 DIGITAL DETECTOR



- Max. detection depth in walls:
- Ferrous metals: 80mm
 - Non-ferrous metals: 50mm
 - Copper conductors: 50mm
 - Wood: 38mm
 - Moisture detection: 8mm
- Moisture/precision test range:
- Wood: 5%-50%/ ±2%.
 - Building materials: 1.5%-33%/ ±2%
- Power supply: 2x1.5V AAA

It can detect metals (iron and non-ferrous metals), wooden beams and live cables hidden in walls, ceilings and floors. It can be used to determine the moisture content of various types of tree species, wood, bamboo items, paper, plasterboard, cement mortar and lime mortar.

Code	Ref.		EAN
5117613	DS5627MK	4 EM 1	5602482056275

LASER DISTANCE METER 30M



- Measuring accuracy: ±5mm (m/in/ft)
 Measuring range (without reflector): 0.03-30m
 Measurement time: 0.3-4 seconds
 Laser type: 620~670nm, <1mw
 Laser shutdown: 15 seconds
 Automatic shutdown: 45 seconds
 Power supply: 2x1.5V AAA
 Dimensions: 90x40x24mm

Used for land survey, bridge erection, ballistic analysis, building survey, interior decoration and other occasions that need to measure distance, length and area.

Code	Ref.		EAN
5117614	DS5628MK	30 metros	5602482056282

LASER DISTANCE METER 60M



- Measuring accuracy: ±3mm (m/in/ft)
 Measuring range: 0.03-40/50/60m
 Measurement time: 0.1-4 seconds
 Laser type: 620~690nm, <1mw
 Laser shutdown: 15 seconds
 Auto shutdown: 120 seconds
 Power supply: 2x1.5V AAA
 Dimensions: 120x56x27mm

Used for land survey, bridge erection, ballistic analysis, building survey, interior decoration and other occasions that need to measure distance, length and area.

Code	Ref.		EAN
5117615	DS5629MK	60 metros	5602482056299

CROSS LINE LASER LEVEL



Horizontal accuracy: $\pm 7\text{mm}/10\text{m}$
 Vertical accuracy: $\pm 7\text{mm}/10\text{m}$
 Automatic leveling range: $\pm 3.5^\circ$
 Laser diode calsse 2: 635nm red light
 Amplification time: <6S
 Operating range (beam): 12 meters
 Power supply: 2 x 1.5V AA
 Dimensions: 80x50x86,5mm

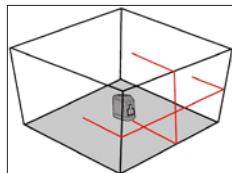

Reliable, durable and professional laser levels, compact size, easy to carry. Vertical and horizontal 2-line laser configuration, simple and easy to operate.

Alcance 12m	Precisão $\pm 7\text{mm}/10\text{m}$	Nivelamento Automático $\pm 3.5^\circ$	2AA*1,5V
----------------	---	---	----------

Code	Ref.		EAN
5117616	DS5630MK		5602482056305

CROSS LINE LASER WITH LINE SIDE



Horizontal accuracy: $\pm 7\text{mm}/10\text{m}$
 Vertical accuracy: $\pm 7\text{mm}/10\text{m}$
 Automatic leveling range: $\pm 3.5^\circ$
 Laser diode calsse 2: 635nm red light
 Amplification time: <6S
 Operating range (beam): 12 meters
 Power supply: 2 x 1.5V AA
 Dimensions: 80x50x86,5mm

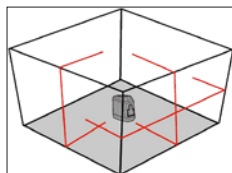

Reliable, durable and professional laser levels, compact size, easy to carry. Vertical and horizontal 2-line laser configuration, simple and easy to operate.

Alcance 12m	Precisão $\pm 7\text{mm}/10\text{m}$	Nivelamento Automático $\pm 3.5^\circ$	2AA*1,5V
----------------	---	---	----------

Code	Ref.		EAN
5117617	DS5631MK		5602482056312

TRIPOD TELESCOPE



Tripé telescópico em alumínio

- Corpo em alumínio extensível e leve.
 - Sistema de clip para o bloqueio dos pés.
- Altura máxima: 1500 mm
 Altura mínima: 500mm

Code	Ref.		EAN
5117618	DS5632MK		5602482056329

PROFESSIONAL COMPASS WITH WING (STEEL)



Code	Ref.			EAN
5106849	7641	150 mm	5	5602482016460
5106850	7641	200 mm	5	5602482016477
5106851	7641	250 mm	5	5602482016484
5106852	7641	300 mm	5	5602482016191

STEEL RIGHT ANGLE RULER



NEW

Code	Ref.			EAN
5116414	DS5910-YF	600 x 100 mm	6	5602482059108

GRADUATED RULER (STEEL)

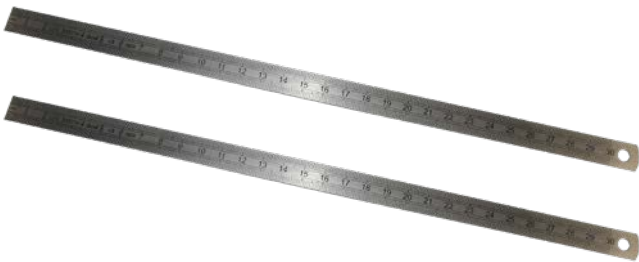

Code	Ref.			EAN
5116438	81.21.101	300 x 30 x 1 mm	20	5602482016507
5118188	81.21.102	500 x 30 x 1 mm	20	5602482039261
5118189	81.21.103	1.000 x 30 x 1 mm	20	5602482039278

SQUARE

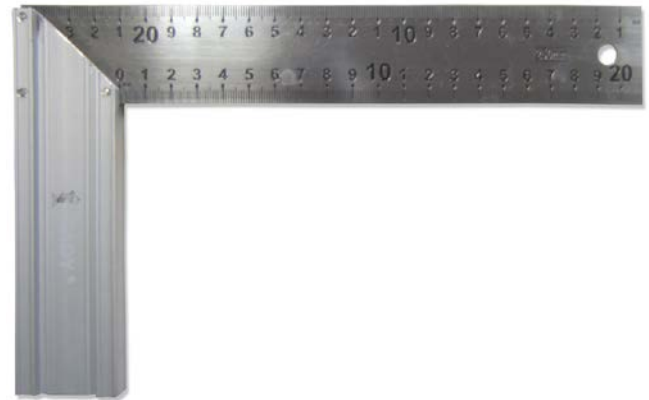

Code	Ref.			EAN
5109705	GWS-25D	250 mm	6	5602482020832
5109706	GWS-30D	300 mm	6	5602482020849
5109707	GWS-40D	400 mm	6	5602482020856
5109708	GWS-50D	500 mm	6	5602482020863

STAINLESS STEEL RULER

NEW

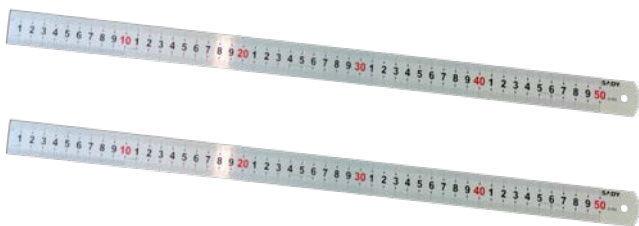

Code	Ref.			EAN
5116415	DS5907-YF	300 x 25 x 0,8 mm	10	5602482059078
5116416	DS5908-YF	500 x 28 x 0,9 mm	10	5602482059085
5116417	DS5909-YF	1.000 x 30 x 1,0 mm	10	5602482059092

STAINLESS STEEL CALIPER



Code	Ref.			EAN
5104225	81101502	150 mm	10	5602482027244

CARPENTER PENCIL



Code	Ref.		EAN
5118045	5518-SS OVAL	 100	5602482003361

LEVEL

NEW



Bubble with vertical view. 2 solid acrylic bubbles. Milled surface. Shock-absorbing plastic support. Trapezoidal body in high strength cast aluminium.
Accuracy: <0.5mm/m.

Code	Ref.		EAN
5116337	DS5897-JYC 600 mm	 5	5602482058972

DEPTH GAUGE PROTRACTOR



Code	Ref.		EAN
5104791	7610 150 mm	 5	5602482016552

LEVEL MAGNÉTIC

NEW



Code	Ref.		EAN
5116336	DS5896-JYC 250 mm	 5	5602482058965

ALUMINIUM RULER WITH LEVEL



Code	Medidas		Precisão	EAN
5118520	1,5 m	100 x 18 mm	0,5mm/M=0.029°	5602482039452
5118521	2 m	100 x 18 mm	0,5mm/M=0.029°	5602482039469
5118522	2,5 m	100 x 18 mm	0,5mm/M=0.029°	5602482039476
5118523	3 m	100 x 18 mm	0,5mm/M=0.029°	5602482039483

ALUMINIUM RULER



Code	Dimensions		EAN
5118136	2 metres	100 x 18 mm	5602482039391
5118137	2,5 metres	100 x 18 mm	5602482039407
5118138	3 metres	100 x 18 mm	5602482039414
5118139	3,5 metres	100 x 18 mm	5602482039421
5118140	4 metres	100 x 18 mm	5602482039438

MEASURING WHEEL



Features	
Wheel	318 mm
Working accuracy	+/- 1%
Unit of measurement	m and dm
Counter	5 digits

Code	Ref.		EAN
5118798	DS5352		5602482053526

LEVEL RAPID



Code	Ref.			EAN
5114358	95B	100 cm	30	5602482006034

WOOD HANDLE



Code	Ref.			EAN
1107857	801	1,20 mt. - rakes	25	5602482031708
1107971	802	1,30 mt. - rakes	25	5602482041233
1107854	303	1,20 mt. - hoes	25	5602482005846
1107867	305	1,30 mt. - hoes	25	5602482031715
1108133	306	1,40 mt. - hoes	25	5602482046962
1107873	702	1,30 mt. - forks	25	5602482030848
1107860	504	1,20 mt. - hoes	25	5602482031753
1107924	505	1,30 mt. - hoes	25	5602482039339

WOOD HANDLE



Code	Ref.			EAN
1107856	401	900 mm - axes	25	5602482031739
1107855	901	900 mm - sledge hammer	25	5602482029279
1107853	201	900 mm - hoes	25	5602482001404

WOOD HANDLE



Code	Ref.			EAN
1107866		240 mm - mason's mallets		5602482031722

WOOD HANDLE



Code	Ref.			EAN
1107881	406	370 mm - machadinhas hacha		5602482030855

WOOD HANDLE



Code	Ref.			EAN
1108139		160 mm barbecue	12	5602482046658
1108140		200 mm barbecue		5602482046665

WOOD HANDLE FOR HAMMERS



Code	Ref.			EAN
1107882	1111	370 mm bevelled		5602482030862
1107864		Nº 1 320 mm - conical		5602482032682
1107865		Nº 2 320 mm - conical		5602482032699
1100750		round		5602482000148
1100751		american type		5602482001343

WOOD HANDLE FOR TOOLS



Code	Ref.			EAN
1100741		Nº 0		5602482032897
1100742		Nº 1		5602482032903
1100743		Nº 2		5602482032910
1100744		Nº 3		5602482032927
1100745		Nº 4		5602482032934
1100746		Nº 5		5602482032941
1100747		Nº 6		5602482032958

WOOD HANDLE FOR FILES



Code	Ref.			EAN
1101267		Nº 0		5602482031746
1101268		Nº 1		5602482024855
1101269		Nº 2		5602482024762
1101270		Nº 3		5602482002203
1101271		Nº 4		5602482024779
1101272		Nº 5		5602482002258
1101273		Nº 6		5602482002340

WOOD HANDLE



Code	Ref.			EAN
1107861	613	shovels	12	5602482032705

IRON WIRE FOLDER



Code	Ref.		EAN
1108025	225 mm		5602482040168

PUNCH



Code	Ref.		EAN
1108230	940 90 mm x Ø 5 mm		5602482049901

“T” BAR CLAMP



Code	Ref.		EAN
1100785	1 m		56024820
1100786	1,25 m		56024820
1100787	1,5 m		56024820
1100788	1,75 m		56024820
1100789	2 m		56024820
1100790	2,25 m		56024820
1100791	2,5 m		56024820

PLUMB BOB LINE



Code	Ref.		EAN
1501023	50 m	12	5602482042384

ELECTRODES



Code	Ref.		EAN
5100684	2 x 300 mm (5 kg.) 520	25	5602482025042
5113137	2,5 x 350 mm (5 kg.) 260	19	5602482025059
5110613	3,25 x 350 mm (5 kg.) 160	19	5602482025066

MASON'S WIRE PT 1



Code	Ref.		EAN
1501030	ASSORTED COLORS 250gr.	4	5602482042711
1501180	YELLOW 250gr.	4	5602482049765
1501181	WHITE 250gr.	4	5602482049777
1501182	ORANGE 250gr.	4	5602482049789
1501183	GREEN 250gr.	4	5602482049796

PLUMB BOB



Code	Ref.		EAN
1107833	Tipo A 900 grams		5602482032491
1107834	Tipo B 1200 grams		5602482032507
1107835	Tipo C 1830 grams		5602482032514
1107836	Tipo D 2350 grams		5602482032521

PLUMB BOB WITH TIP (WITH MAGNET)



Code	Ref.		EAN
1107868	Tipo A 900 grams		5602482032538
1107869	Tipo B 1200 grams		5602482032545
1107870	Tipo C 1830 grams		5602482032552

PLUMB BOB WITH TIP



Code	Ref.		EAN
1107824	Nº 7 1000 grams		5602482023086
1107825	Nº 8 1200 grams		5602482023093

PLUMB BOB



Code	Ref.		EAN
1101048	Nº 3 190 grams		5602482032576
1101049	Nº 4 210 grams		5602482032583
1101050	Nº 5 240 grams		5602482015173
1101051	Nº 6 290 grams		5602482015395
1101052	Nº 7 360 grams		5602482015180
1101053	Nº 8 410 grams		5602482032590

PLUMB BOB



Code	Ref.		EAN
1101041	Nº 3 290 grams		5602482032569
1101042	Nº 4 350 grams		5602482015197
1101043	Nº 5 400 grams		5602482009486
1101044	Nº 6 440 grams		5602482015203
1101045	Nº 7 520 grams		5602482009493
1101046	Nº 8 620 grams		5602482015210

ANGLED PLASTERING TROWEL



Code	Ref.		EAN
1107501	Nº 1	295 x 160 mm	5604745121324

PLÁSTIC TROWEL



Code	Ref.		EAN
1107839	Nº 4	445 x 145 mm	5604745121355

PLÁSTIC TROWEL



Code	Ref.		EAN
1107500	Nº 1	260 x 160 mm	5604745121317
1101062	Nº 2	340 x 220 mm	5604745121331
1107526	Nº 3	415 x 255 mm	5604745121348

PLÁSTIC TROWEL (WITH SAND)

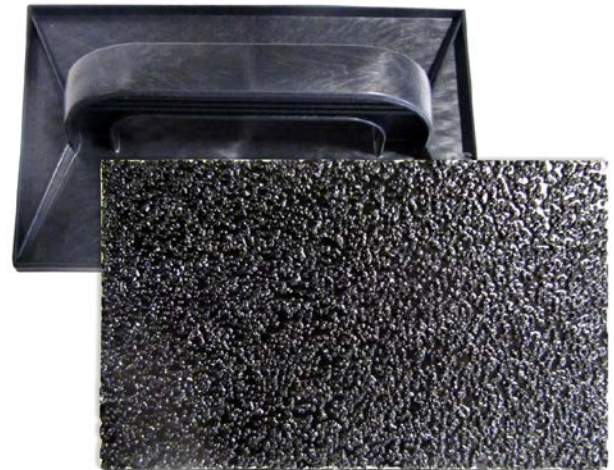

Code	Ref.		EAN
1108112	Nº 1	260 x 160 mm	5602482045002
1108113	Nº 2	340 x 220 mm	5602482045019

PLÁSTIC TROWEL (WHITE)

TALOCHA PLÁSTICA (BLANCA)



Code	Ref.		EAN
1107859	Nº 2	340 x 220 mm	5602482031937

PLÁSTIC TROWEL



Code	Ref.		EAN
1107516	Nº 1	300 x 30 mm	5604745121515
1107517	Nº 2	360 x 50 mm	5604745121522
1107518	Nº 3	380 x 70 mm	5604745121539

PLÁSTIC TROWEL (WITH SPONGE)



Code	Ref.		EAN
1108116	Nº 1	265 x 160 x 30 mm	5604745121379

PLASTIC TRAY



Code	Ref.		EAN
1500891	nº 1	420 x 310 x 95 mm	5604745321311

ANGLED PLASTERING TROWEL (WITH SPONGE)



Code	Ref.		EAN
1108117	Nº 1	300 x 160 x 30 mm	5604745121386

PLASTIC TRAY



Code	Ref.		EAN
1500892	nº 2	495 x 408 x 110 mm	5604745321328

PLASTIC BUCKET



Code	Ref.		EAN
1500920	10 Liters	25	5604745221314
1500923	15 Liters	25	5604745221321

PLASTIC TRAY (35 LITERS)



Code	Ref.		EAN
1500912	nº 3	630 x 470 x 160 mm	5604745321335

WOOD AND PVC BLADE



Cutting discs to be used with angle grinders.
Application: Wood without nails or other metallic objects and PVC.

Code	Ref.	Diam. x Thk. x Hole		EAN
5112213	56115614	115 x 1,4 x 22,2 mm		5602482042001
5112329	56230616	230 x 1,6 x 22,2 mm		5602482042339

HSS SAW BLADE



Blade to be used in metal.

Code	Ref.	Diam. x Thk. x Hole		EAN
5109581	262251932	225 x 1,9 x 32 mm / 180T		5602482028487
5103657	262502032	250 x 2,0 x 32 mm / 200T		5602482013186
5109582	262502532	250 x 2,5 x 32 mm / 200T		5602482028494

CARBIDE TIP BLADE FOR ALUMINIUM



For all types of non-ferrous metals, such as aluminium, brass, copper and lead.

Code	Ref.	Diam. x Thk. x Hole		EAN
5109583	232503232	250 x 3,2 x 32 mm / 80T		5602482025516
5103662	232333282	300 x 3,2 x 32 mm / 72T		5602482028500

CARBIDE TIP BLADE FOR WOOD



Blade for the fast cutting of wood.

Code	Ref.	Diam. x Thk. x Hole		EAN
5101195	221403020	140 x 20 x 2,2 mm / 30T		5602482028531
5109585	221604820	160 x 20 x 2,2 mm / 48T		5602482028548
5109586	221844830	184 x 30 x 2,4 mm / 48T		5602482025530
5118780	DS5623-24T	185 x 16 x 2,4 mm / 24T		5602482056237
5116419	DS5872-48T	185 x 16 x 2,4 mm / 48T		5602482058729
5114382	221904830	190 x 30 x 2,4 mm / 48T		5602482046672
5103658	56520032	200 x 30 x 2,8 mm / 32T		5602482024212
5109587	222104830	210 x 30 x 2,4 mm / 48T		5602482025547
5101196	222164830	216 x 30 x 2,4 mm / 48T		5602482028470
5109588	222354830	235 x 30 x 2,2 mm / 48T		5602482000971
5103659	56525040	250 x 30 x 2,2 mm / 40T		5602482013070
5103660	56530048	300 x 30 x 3,2 mm / 48T		5602482013391
5105265	56530060	300 x 30 x 3,2 mm / 60T		5602482019058
5104136	56535060	350 x 30 x 3,2 mm / 60T		5602482013100
5118839	DS5621-24T	315 x 30 x 2,0 mm / 24T		5602482056213
5118840	DS5622-48T	315 x 30 x 2,0 mm / 48T		5602482056220

CARBIDE TIP BLADE FOR BRUSHCUTTERS



Blades for the cutting of weeds, tree branches, ...

Code	Ref.	Diam. x Thk. x Hole		EAN
5107579	2425525436	255 x 1,5 x 25,4 mm / 36T		5602482019034
5107580	2425525440	255 x 1,5 x 25,4 mm / 40T		5602482019041

CARBIDE TIP BLADE FOR BRUSHCUTTERS



Blades for the cutting of weeds, tree branches, ...

Code	Ref.	Diam. x Thk. x Hole		EAN
5118661	TF-1111	255 x 2,5 x 25,4 mm / 20T		5602482040274

CARBIDE TIP BLADE FOR BRUSHCUTTERS



Blades for the cutting of weeds, tree branches, ...

Code	Ref.	Diam. x Thk. x Hole		EAN
5118699		255 x 2,0 x 25,4 mm / 24T		5602482040311
5118700	27225036	255 x 2,0 x 25,4 mm / 36T		5602482040328
5118701		255 x 2,0 x 25,4 mm / 40T		5602482040335

BRUSHCUTTER BLADE - 2 TEETH



Blades for cutting weeds, lawns, thinning of flowers and plants, ...

Code	Ref.	Diam. x Thk. x Hole		EAN
5107581	253052542	300 x 3,0 x 25,4 mm / 2T		5602482022836

BRUSHCUTTER BLADE - 3 TEETH



Blades for cutting weeds, lawns, thinning of flowers and plants, ...

Code	Ref.	Diam. x Thk. x Hole		EAN
5107582		300 x 3,0 x 25,4 / 3T		5602482026049

HSS TWIST DRILL BIT

Code	Ref.		EAN
5112903	41306000	6 x 400 mm	5602482043114
5112904	41308000	8 x 400 mm	5602482043121
5112905	41308001	8 x 600 mm	5602482043138
5112906	41310000	10 x 400 mm	5602482043145
5112907	41310001	10 x 600 mm	5602482043152
5112908	41312000	12 x 400 mm	5602482043169
5112909	41312001	12 x 600 mm	5602482043176
5112910	41314001	14 x 600 mm	5602482043183
5112911	41316001	16 x 600 mm	5602482043190

BRAD POINT WOOD DRILL BIT

Recommended for drilling along cavities in wooden or plaster walls, (even if they have nails or other mandal pieces), without damaging the exterior finish.

Code	Ref.		EAN
5116153		6 x 250 mm	5602482056381
5116154		8 x 250 mm	5602482056398
5116155		10 x 250 mm	5602482056404
5116156		12 x 250 mm	5602482056411
5116157		14 x 250 mm	5602482056428
5109572		8 x 600 mm	5602482002975
5109573		10 x 600 mm	5602482002982
5109574		12 x 600 mm	5602482003224
5109575		14 x 600 mm	5602482003231

CONCRETE DRILL BIT



Code	Ref.		EAN
5106472		3 mm	5602482031951
5106473		3,5 mm	5602482035928
5106474		4 mm	5602482014480
5106475		4,5 mm	5602482035935
5106476		5 mm	5602482014947
5106477		5,5 mm	5602482035942
5106478		6 mm	5602482018938
5106479		6,5 mm	5602482035959
5106480		7 mm	5602482019003
5106481		7,5 mm	5602482035966
5106482		8 mm	5602482019010
5106483		8,5 mm	5602482035973
5106484		9 mm	5602482031968
5106485		9,5 mm	5602482035980
5106486		10 mm	5602482019027
5106487		11 mm	5602482031975
5106488		12 mm	5602482019850
5106489		13 mm	5602482020412
5106490		14 mm	5602482031982
5106491		15 mm	5602482031999
5106492		16 mm	5602482032002
5106493		18 mm	5602482032019
5106494		20 mm	5602482032026
5106495		22 mm	5602482032033
5109874		25 mm	5602482032040

LONG

5106496		300 x 6 mm	5602482012011
5106497		300 x 8 mm	5602482002425
5106498		300 x 10 mm	5602482002432
5106499		300 x 12 mm	5602482002449
5106500		30 x 14 mm	5602482002456
6106501		30 x 16 mm	5602482002463
5106502		300 x 18 mm	5602482002470
5106503		300 x 20 mm	5602482002487
5106504		400 x 6 mm	5602482012028
5106505		400 x 8 mm	5602482002494
5106506		400 x 10 mm	5602482002500
5106507		400 x 12 mm	5602482002517
5106508		400 x 14 mm	5602482002524
5106509		400 x 16 mm	5602482002531
5106510		400 x 18 mm	5602482002548
5106511		400 x 20 mm	5602482002555

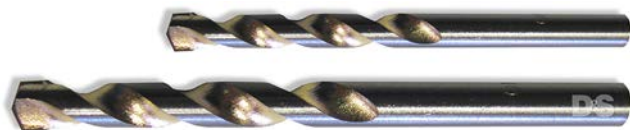
CONCRETE DRILL BIT - SUPER



Code	Ref.		EAN
5109473	3 mm	100	5602482020528
5109474	4 mm	100	5602482020535
5104999	5 mm	100	5602482017436
5102466	6 mm	100	5602482017443
5105000	7 mm	100	5602482017450
5102467	8 mm	100	5602482017467
5103422	10 mm	100	5602482017474
5100871	11 mm	50	5602482022669
5102469	12 mm	50	5602482017481
5109478	13 mm	35	5602482020542
5109475	14 mm	35	5602482020559
5109476	15 mm	35	5602482020566
5109477	16 mm	30	5602482020573

BRAD POINT WOOD DRILL BIT

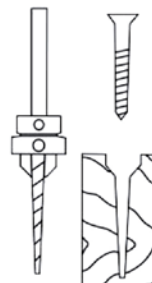

HSS manufactured drill bits with 5 cutting edges, adjustable. To be used with any type of wood screws: flat, round or oval head. To be used on wood, plastic, soft mand al, ... Compland e with an allen-type key.

Code	Ref.		EAN
5112912	49400030 3 mm		5602482043206
5112913	49400040 4 mm		5602482043213
5112914	49400050 5 mm		5602482043220
5112915	49400060 6 mm		5602482043237

CONCRETE DRILL BIT SET



Contents:

- 5 pieces: 4; 5; 6; 8 and 10 mm
- 8 pieces: 3; 4; 5; 6; 7; 8; 9 and 10 mm

Code	Ref.		EAN
5103443	5 drill bits		5602482014633
5105309	8 drill bits		5602482014640

HSS DRILL BIT BOX



Contents:

- 13 pieces: 1,5 to 7,5 mm
- 19 pieces: 1 to 10 mm (spacing of 0,5 mm)
- 25 pieces: 1 to 13 mm (spacing of 0,5 mm)

Code	Ref.		EAN
5102462	13 drill bits metallic box		5602482002753
5100183	19 drill bits metallic box		5602482002777
5102668	25 drill bits metallic box		5602482015340

HSS DRILL BIT



Code	Ref.		EAN
5106691	0,5 mm	10	5602482035997
5106692	0,75 mm	10	5602482036000
5106693	0,8 mm	10	5602482036017
5105768	1 mm	10	5602482036024
5105769	1,25 mm	10	5602482036031
5105770	1,5 mm	10	5602482027350
5105771	1,75 mm	10	5602482036048
5105772	2 mm	10	5602482027367
5105773	2, 25 mm	10	5602482036055
5105774	2,5 mm	10	5602482027374
5105775	2,75 mm	10	5602482036062
5105776	3 mm	10	5602482027381
5105777	3,25 mm	10	5602482036079
5105778	3,5 mm	10	5602482027398
5105779	3,75 mm	10	5602482027404
5105780	4 mm	10	5602482027411
5105781	4,25 mm	10	5602482027428
5105782	4,5 mm	10	5602482027435
5105783	4,75 mm	10	5602482027442
5105784	5 mm	10	5602482027459
5105785	5,25 mm	10	5602482026086
5105786	5,5 mm	10	5602482027466
5105787	5,75 mm	10	5602482036093
5105788	6 mm	10	5602482027473
5105789	6,25 mm	10	5602482036109
5105790	6,5 mm	10	5602482027480
5105791	6,75 mm	10	5602482036116
5105792	7 mm	10	5602482027497
5105793	7,25 mm	10	5602482036123
5105794	7,5 mm	10	5602482027503
5105795	7,75 mm	10	5602482036130
5105796	8 mm	10	5602482027510
5105797	8,25 mm	10	5602482036147
5105798	8,5 mm	10	5602482027527
5105800	9 mm	10	5602482027534
5105801	9,25 mm	10	5602482036154
5105802	9,5 mm	10	5602482027541
5105804	10 mm	10	5602482027558
5105805	10,5 mm	10	5602482036161
5105806	11 mm	10	5602482027565
5105807	11,5 mm	10	5602482027572
5105808	12 mm	5	5602482027589
5105809	12,5 mm	5	5602482036178
5105810	13 mm	5	5602482027596
5105811	13,5 mm	5	5602482036185
5105812	14 mm	5	5602482036192

HSS DRILL BIT REDUCED SHANK

Code	Ref.		EAN
5105813	14,5 mm	5	5602482036208
5105814	15 mm	5	5602482036215
5105815	15,5 mm	5	5602482036222
5105816	16 mm	5	5602482036239
5105825	16,5 mm	4	5602482036246
5105817	17 mm	4	5602482036253
5105818	17,5 mm	5	5602482036260
5105819	18 mm	4	5602482036277
5105820	18,5 mm	5	5602482036284
5105821	19 mm	4	5602482036291
5105822	19,5 mm	5	5602482036307
5105823	20 mm	4	5602482036314



COBALT HSS DRILL BIT (8%)



Code	Ref.		EAN
5108872	1 mm	10	5602482019355
5105573	1,25 mm	10	5602482019362
5108874	1,5 mm	10	5602482019379
5108875	1,75 mm	10	5602482019386
5108876	2, mm	10	5602482019393
5108877	2,25 mm	10	5602482019409
5108878	2,5 mm	10	5602482019416
5108879	2,75 mm	10	5602482019423
5108880	3 mm	10	5602482019430
5108881	3,25 mm	10	5602482019447
5108882	3,5 mm	10	5602482019454
5108883	3,75 mm	10	5602482019461
5108884	4 mm	10	5602482019478
5108885	4,25 mm	10	5602482019485
5108886	4,5 mm	10	5602482019492
5108887	4,75 mm	10	5602482019508
5108888	5 mm	10	5602482019515
5108889	5,25 mm	10	5602482019522
5108890	5,5 mm	10	5602482019535
5108891	5,75 mm	10	5602482019546
5108892	6 mm	10	5602482019553
5108893	6,25 mm	10	5602482019560
5108894	6,5 mm	10	5602482019577
5108895	7 mm	10	5602482019584
5108896	7,5 mm	10	5602482019591
5108897	8 mm	10	5602482019607
5108898	8,5 mm	5	5602482019614
5108899	9 mm	5	5602482019651
5108900	9,5 mm	5	5602482019638
5108901	10 mm	5	5602482019645
5108902	10,5 mm	5	5602482019652
5108903	11 mm	5	5602482019669
5108905	11,5 mm	5	5602482019676
5108905	12 mm	5	5602482019683
5108906	12,5 mm	5	5602482019690
5108907	13 mm	5	5602482019706

RECTIFIED HSS DRILL BIT SET



Contents:

- 19 pieces: 1 to 10 mm (spacing of 0,5 mm)
- 25 pieces: 1 to 13 mm (spacing of 0,5 mm)

Code	Ref.		EAN
5106166	19 drill bits metallic box		5602482015333
5108855	25 drill bits metallic box		5602482014244

COBALT HSS DRILL BIT (8%)



Contents

- 1 to 8 mm: 10 drills each size
- 8,5 to 10 mm: 5 drills each size

Code	Ref.		EAN
5108857	170 drill bits metal box		5602482013582

RECTIFIED HSS DRILL BIT



Code	Ref.		EAN
5106133	1 mm	10	5602482036321
5108111	1,25 mm	10	5602482036338
5106134	1,5 mm	10	5602482036345
5108112	1,75 mm	10	5602482036352
5106135	2 mm	10	5602482036369
5106136	2,25 mm	10	5602482036376
5106137	2,5 mm	10	5602482036383
5106138	2,75 mm	10	5602482036390
5106139	3 mm	10	5602482036406
5106140	3,25 mm	10	5602482036413
5106141	3,5 mm	10	5602482036420
5106142	3,75 mm	10	5602482036437
5106143	4 mm	10	5602482036444
5106144	4,25 mm	10	5602482036451
5106145	4,5 mm	10	5602482036468
5106146	4,75 mm	10	5602482036475
5106147	5 mm	10	5602482036482
5106148	5,25 mm	10	5602482036499
5106149	5,5 mm	10	5602482036505
5106150	5,75 mm	10	5602482036512
5106151	6 mm	10	5602482036529
5108113	6,25 mm	10	5602482036536
5106152	6,5 mm	10	5602482036543
5106153	7 mm	10	5602482036550
5106154	7,5 mm	10	5602482036567
5106155	8 mm	10	5602482036574
5106156	8,5 mm	10	5602482036581
5106157	9 mm	10	5602482036598
5106158	9,5 mm	10	5602482036604
5106159	10 mm	10	5602482036611
5106160	10,5 mm	10	5602482036628
5106161	11 mm	10	5602482036635
5106162	11,5 mm	10	5602482036642
5106163	12 mm	5	5602482036659
5106164	12,5 mm	5	5602482036666
5106165	13 mm	5	5602482036673

RECTIFIED HSS DRILL BIT



Code	Ref.		EAN
5108858	13,5 mm	5	5602482036680
5108859	14 mm	5	5602482036697
5108860	14,5 mm	5	5602482036703
5108861	15 mm	5	5602482036710
5108862	15,5 mm	5	5602482036727
5108863	16 mm	5	5602482036734
5108864	16,5 mm	4	5602482036741
5108865	17 mm	4	5602482036758
5108866	17,5 mm	4	5602482036765
5108867	18 mm	4	5602482036772
5108868	18,5 mm	4	5602482036789
5108869	19 mm	4	5602482036796
5108870	19,5 mm	4	5602482036802
5108871	20 mm	4	5602482036819

RECTIFIED HSS DRILL BIT



Contents

- 1 to 8 mm: 10 drills each size
- 8,5 to 10 mm: 5 drills each size

Code	Ref.		EAN
5108856	170 drill bits metal box		5602482013575

SDS DRILL BIT FOR STONE



Code	Ref.		EAN
5106512	4 x 100 mm		5602482017252
5106513	5 x 110 mm		5602482017269
5109472	5 x 160 mm		5602482015623
5106694	5,5 x 110 mm		5602482017498
5106695	5,5 x 160 mm		5602482017504
5106514	6 x 110 mm		5602482006041
5106515	6 x 160 mm		5602482005877
5106696	6 x 210 mm		5602482017511
5106697	6,5 x 110 mm		5602482017528
6106698	6,5 x 160 mm		5602482017535
5106516	7 x 110 mm		5602482017276
5106517	7 x 160 mm		5602482017283
5106518	8 x 110 mm		5602482005884
5106519	8 x 160 mm		5602482006003
5106520	8 x 210 mm		5602482017290
5106521	10x 110 mm		5602482017306
5106522	10 x 160 mm		5602482006010
5106523	10 x 210 mm		5602482006805
5106524	10 x 260 mm		5602482009639
5106525	10 x 410 mm		5602482017313
5106526	12 x 160 mm		5602482006027
5106527	12 x 210 mm		5602482009646
5106528	12 x 260 mm		5602482006881
5106529	12 x 410 mm		5602482017320
5106530	14 x 160 mm		5602482006812
5106531	14 x 210 mm		5602482009653
5106532	14 x 260 mm		5602482009660
5106533	14 x 410 mm		5602482017337
5106534	15 x 160 mm		5602482017344
5106700	15 x 210 mm		5602482017351
5100872	15 x 410 mm		5602482022676
5106535	16 x 210 mm		5602482006829
5106536	16 x 260 mm		5602482009677
5106536	16 x 410 mm		5602482017368
5106538	18 x 210 mm		5602482009684
5106539	18 x 260 mm		5602482009691
5106540	18 x 410 mm		5602482017375
5106541	20 x 210 mm		5602482009707
5106542	20 x 260 mm		5602482006836
5106543	20 x 410 mm		5602482017382
5106544	22 x 260 mm		5602482017399
5106545	22 x 410 mm		5602482017405
5106701	25 x 260 mm		5602482017412
5106546	25 x 410 mm		5602482017429

BRAD POINT WOOD DRILL BIT



Code	Ref.		EAN
5109424	3 mm		560248202
5109425	4 mm		560248202
5103398	5 mm		560248202
5103399	6 mm		560248202
5103400	7 mm		560248202
5103401	8 mm		560248202
5103403	10 mm		560248202
5103404	12 mm		560248202
5103405	14 mm		560248202
5103406	16 mm		560248202

BRAD POINT WOOD DRILL BIT SET



Contents:

- 8 pieces: 3; 4; 5; 6; 7; 8; 9 and 10 mm

Code	Ref.		EAN
5102464	8 pieces plastic box		5602482002869



Diógenes & Santos, S.A.

**Rua Albino Moreira, 360
4485-767 Vilar VCD - PORTUGAL**

**Tel.: 226 076 310
email: geral@diosan.com**

www.sady.pt