

SADY®



Catálogo



2022

Ferramentas Manuais



SADY[®]

ferramentas manuais
herramientas manuales



 **D&S**



FERRAMENTAS



MAÇARICO METÁLICO - HURRICANE

MAÇARICO METÁLICO - HURRICANE



Queimador: Ø 20 mm
Consumo: 111 g/h
Potência: 2,1 kW

Queimador: Ø 20 mm
Consumo: 111 g/h
Potência: 2,1 kW



Código	Ref.		EAN
5110153	100P	c/isqueiro con encendedor 	6 6934589405526

MAÇARICO PLÁSTICO - TYPHOON

SOPLETE PLASTICO - TYPHOON

Queimador: Ø 28 mm
Consumo: 127 g/h
Potência: 1,76 kW

Queimador: Ø 28 mm
Consumo: 127 g/h
Potência: 1,76 kW



Código	Ref.		EAN
5104940	120P	c/isqueiro con encendedor 	6 6934589405618

MAÇARICO METÁLICO - TYPHOON

SOPLETE METALICO - TYPHOON

Queimador: Ø 20 mm
Consumo: 127 g/h
Potência: 1,76 kW

Queimador: Ø 20 mm
Consumo: 127 g/h
Potência: 1,76 kW



Código	Ref.		EAN
5105270	100P	c/isqueiro con encendedor 	6 6934589405519

MAÇARICO PLÁSTICO - TYPHOON

SOPLETE PLASTICO - TYPHOON

Queimador: Ø 28 mm
Consumo: 127 g/h
Potência: 1,76 kW

Queimador: Ø 28 mm
Consumo: 127 g/h
Potência: 1,76 kW



Código	Ref.		EAN
5104939	120	s/isqueiro sin encendedor 	6 6934589405601

MAÇARICO METÁLICO - TYPHOON

SOPLETE METALICO - TYPHOON

Queimador: Ø 20 mm
Consumo: 127 g/h
Potência: 1,76 kW

Queimador: Ø 20 mm
Consumo: 127 g/h
Potência: 1,76 kW



Código	Ref.		EAN
5105271	100	s/isqueiro sin encendedor 	6 6934589405502

GÁS BUTANO (ILL)

GAS BUTANO (ILL)



Código	Ref.		EAN
5511050		cartucho 190 g 	36 5602482042278

CHAMUSCADOR COM 3 CABEÇOS
SOPLETE CON 3 QUEMADORES



CHAMUSCADOR
SOPLETE



Consumo: 2.500 g/h
Potência: 35 kW
Comprimento total: 430 mm

Consumo: 2.050 g/h
Potência: 35 kW
Longitud total: 430 mm

Código	Ref.	cabeços consumos		EAN
5106021	I008L	Ø 25 mm 250 g/h Ø 35 mm 450 g/h Ø 50 mm 2.000 g/h	6	6934589410353

Código	Ref.		EAN
5104969	I048L	Ø 60 mm	6 6934589411152

CHAMUSCADOR
SOPLETE



Consumo: 450 g/h
Potência: 6.3 kW
Comprimento total: 360 mm

Consumo: 450 g/h
Potência: 6.3 kW
Longitud total: 360 mm

Código	Ref.		EAN
5104935	I044L	Ø 35 mm	6 6934589410957

CHAMUSCADOR
SOPLETE



Consumo: 3.850 g/h
Potência: 54 kW
Comprimento total: 580 mm

Consumo: 3.850 g/h
Potência: 54 kW
Longitud total: 580 mm

Código	Ref.		EAN
5104937	I066L	Ø 76 mm	6 6934589411503

CHAMUSCADOR
SOPLETE



Consumo: 1.400 g/h
Potência: 19.5 kW
Comprimento total: 400 mm

Consumo: 1.400 g/h
Potência: 19.5 kW
Longitud total: 400 mm

Código	Ref.		EAN
5104936	I046L	Ø 45 mm	6 6934589411053

CABEÇOS PARA CHAMUSCADORES
QUEMADORES



Código	Ref.		EAN
5104941	I335	Ø 35 mm 450 g/l 6,3 kW	30 6934589414450
5104942	I336	Ø 45 mm 1.400 g/l 19,5 kW	60 6934589414467
5108462	I338	Ø 60 mm 2.500 g/l 35 kW	24 6934589414481
5104943	I339	Ø 76 mm 3.850 g/l 54 kW	24 6934589414498

FERRO DE SOLDAR A GÁS

SOPLETE A GAS



Consumo: 140 g/h
Potência: 1,4 kW
Comprimento total: 310 mm

Consumo: 140 g/h
Potencia: 1,4 kW
Longitud total: 310 mm

Código	Ref.		EAN
5104933	I001 17 mm	 6	6934589410001

CAVILHA PARA FERROS SOLDAR

CABEZAL PLANO



Código	Ref.		EAN
5105507	I440 cobre 200 g		6934589413804

FERRO DE SOLDAR A GÁS

SOPLETE A GAS



Consumo: 140 g/h
Potência: 2,1 kW
Comprimento total: 410 mm

Consumo: 140 g/h
Potencia: 2,1 kW
Longitud total: 410 mm
Estes sopletes son apropiados para soldar tubos de cobre

Estes ferros são apropriados para soldar tubos de cobre

Código	Ref.		EAN
5104934	I010L Ø 22 mm	 6	6934589410407

PONTEIRA PARA DECAPAR

QUEMADOR PLANO



Consumo: 140 g/h
Potência: 2,8 kW

Consumo: 140 g/h
Potencia: 2,8 kW

Código	Ref.		EAN
5105824	I325 Ø 40 mm		6934589413422

MAÇARICO A GÁS

SOPLETE A GAS



Consumo: 127 g/h
Potência: 1,76 kW
1 mt. tubo borracha / 3 queimadores (Ø 20/ 24/ 40 mm), 1 ponteira soldar

Consumo: 127 g/h
Potencia: 1,76 kW
1 mt. mangueira caucho / 3 queimadores (Ø 20/ 24/40 mm), 1 punta soldar

Código	Ref.		EAN
5118016	SET 2 s/isqueiro sin encendedor		6934589405816

FOGAREIRO METÁLICO
FOGÓN DE CAMPING



Consumo: 97,5 g/h
Potência: 1,3 kW

Consumo: 97,5 g/h
Potência: 1,3 kW

Código	Ref.			EAN
5105509	COOK100P	c/isqueiro con encendedor	6	6934589406417
5108704	COOK100	s/isqueiro sin encendedor	6	6934589406400

FOGAREIRO CROMADO
FOGAREIRO CROMADO



Consumo: 78 g/h
Potência: 1,35 kW

Consumo: 78 g/h
Potência: 1,35 kW

Código	Ref.		EAN
5106801	COOK200C	campingas	6 6934589408022
5118166	COOK100F	flaga	6 6934589408053

LANTERNA METÁLICA
LINTERNA DE CAMPING



Consumo: 82,5 g/h
Potência: 1,1 kW

Consumo: 82,5 g/h
Potência: 1,1 kW

Código	Ref.		EAN
5105508	FLY100P	c/isqueiro con encendedor	6 6934589407414
5110476	FLY100	s/isqueiro sin encendedor	6 6934589407407

CAMISA PARA LANTERNAS
CAMISA PARA LINTERNAS



Código	Ref.		EAN
5108463	I310	100 W (3) (FLY 100/100P)	24 6934589413255
5108018	I312	500 W (3) (FLY 500C)	24 6934589413262

VIDRO PARA LANTERNAS
VIDRIO PARA LINTERNAS



Código	Ref.		EAN
5105131	I300	Ø 81 mm (FLY 100/100P)	12 6934589413255
5108018	I312	Ø 120 mm (FLY 500C)	6934589413262

FOGÃO ESMALTADO A GÁS

FOGÓN A GAS



Consumo: 69/98 g/h
Potência: 2,6 kW
Dimensões:
Altura: 80 mm / Largura: 480 mm
Profundidade: 290 mm

Consumo: 69/98 g/h
Potencia: 2,6 kW
Dimensiones:
Altura: 80 mm / Anchura: 480 mm
Profundidad: 290 mm

Código	Ref.		EAN
5109248	MULTIFIRE2 2 bocas		6934589409302

FOGÃO INDUSTRIAL A GÁS

FOGÓN INDUSTRIAL A GAS



Consumo: 544 g/h
Potência: 7,5 kW
Dimensões:
Altura: 180 mm / Largura: 390 mm
Profundidade: 390 mm

Consumo: 544 g/h
Potencia: 7,5 kW
Dimensiones:
Altura: 180 mm / Anchura: 390 mm
Profundidad: 390 mm

Código	Ref.		EAN
5109247	POWERFIRE4		6934589409104

FOGÃO ESMALTADO A GÁS

FOGÓN A GAS



Consumo: 47/69/98 g/h
Potência: 4,1 kW
Dimensões:
Altura: 80 mm / Largura: 560 mm
Profundidade: 290 mm

Consumo: 47/69/98 g/h
Potencia: 4,1 kW
Dimensiones:
Altura: 80 mm / Anchura: 560 mm
Profundidad: 290 mm

Código	Ref.		EAN
5109249	MULTIFIRE3 3 bocas		6934589409401

BETUMADEIRA INOX - CABO BI-MATÉRIA
ESPÁTULA INOX - MANGO BICOMPONENTE



Código	Ref.			EAN
5110486	2189SS	20 mm	12	5602482027688
5110487	2190SS	30 mm	12	5602482027695
5110492	2195SS	80 mm	12	5602482027749
5110493	2197SS	100 mm	12	5602482027756
5110494	2199SS	120 mm	12	5602482027763

ESPÁTULA INOX - CABO BI-MATÉRIA
ESPÁTULA INOX - MANGO BICOMPONENTE



Código	Ref.			EAN
5114815	DS5008	25 mm	6	5602482050082
5114816	DS5009	40 mm	6	5602482050099
5114817	DS5010	50 mm	6	5602482050105
5114818	DS5011	65 mm	6	5602482050112
5114819	DS5012	75 mm	6	5602482050129
5114820	DS5013	100 mm	6	5602482050136
5114821	DS5014	125 mm	6	5602482050143

COLHER PONTA REDONDA - CABO COMPÓSITO
PALETA - MANGO BICOMPONENTE



Código	Ref.			EAN
5118747	DS4194	6" 150 mm	12	5602482054301
5118748	DS5432	8" 200 mm	12	5602482054325
5118749	DS5433	8.1/2" 215 mm	12	5602482054332
5118750	DS4196	9" 230 mm	12	5602482041967

COLHER BICO - CABO COMPÓSITO
PALETA CON MANGO BICOMPONENTE



Código	Ref.			EAN
5118754	DS4191	6" 150 mm	12	5602482041912

COLHER CANTOS CORTADOS - CABO COMPÓSITO
PALETA - MANGO BICOMPONENTE



Código	Ref.			EAN
5118751	DS5430	8" 200 mm	12	5602482054301
5118752	DS4192	8.1/2" 215 mm	12	5602482041929
5118753	DS5431	9" 230 mm	12	5602482054318

FORMÃO
FORMÓN



Código	Ref.			EAN
5109709	XS4022	6 mm	10	5602482014152
5109710	XS4022	8 mm	10	5602482014459
5109711	XS4022	10 mm	10	5602482014589
5109712	XS4022	12 mm	10	5602482014596
5109713	XS4022	15 mm	10	5602482014756
5109714	XS4022	18 mm	10	5602482014763
5109715	XS4022	20 mm	10	5602482014848
5109716	XS4022	22 mm	10	5602482015111
5106717	XS4022	25 mm	10	5602482015722
5109718	XS4022	28 mm	10	5602482016545
5109719	XS4022	30 mm	10	5602482016798
5109720	XS4022	35 mm	10	5602482016859
5109721	XS4022	38 mm	10	5602482017108

ALICATE BICO CHATO
ALICATE BOCA PLANA



Código	Ref.		EAN
5101169	6" 150 mm	6	5602482023321

ALICATE DESNUDAR
ALICATE PELACABLES



Código	Ref.		EAN
5101189	6" 150 mm	6	5602482023437

ALICATE CORTE LATERAL
ALICATE CORTE LATERAL



Código	Ref.		EAN
5101171	6" 150 mm	6	5602482023345

ALICATE TELEFONE CURVO
ALICATE PUNTA CURVA



Código	Ref.		EAN
5101172	8" 200 mm	6	5602482023352

ALICATE CORTE DIAGONAL
ALICATE CORTE DIAGONAL EXTRA FUERTE



Código	Ref.		EAN
5101184	7" 180 mm	6	5602482023413
5101185	8" 200 mm	6	5602482023420

ALICATE TELEFONE DIREITO
ALICATE PUNTA RECTA



Código	Ref.		EAN
5101173	6" 150 mm	6	5602482023369
5101174	8" 200 mm	6	5602482023376

ALICATE CORTE FRONTAL
ALICATE CORTE FRONTAL



Código	Ref.		EAN
5101191	6" 150 mm	6	5602482023451
5101192	8" 200 mm	6	5602482023468

ALICATE UNIVERSAL
ALICATE UNIVERSAL



Código	Ref.		EAN
5101180	6" 150 mm	6	5602482023383
5101181	7" 180 mm	6	5602482023390
5101182	8" 200 mm	6	5602482023406

ALICATE BICO CHATO

ALICATE BOCA PLANA



Código	Ref.		EAN
5106184	FN P6	6" 150mm	5602482017832

ALICATE EXTENSIVO

ALICATE DE CREMALLERA



Código	Ref.		EAN
5101190	DS2344	10" 250 mm	5602482023444

ALICATE CORTE FRONTAL

ALICATE CORTE FRONTAL



Código	Ref.		EAN
5106829	EN P6	6" 150 mm	5602482017863
5106830	EN P8	8" 200 mm	5602482017870

ALICATE EXTENSIVO

ALICATE DE CREMALLERA



Código	Ref.		EAN
5109644		10" 250 mm	5602482012691
5109645		12" 300 mm	5602482012752

ALICATE TELEFONE DIREITO

ALICATE PUNTA RECTA



Código	Ref.		EAN
5106186	LNP6	6" 150 mm	5602482017917
5106187	LNP8	8" 200 mm	5602482017924

ALICATE DESNUDAR FIO

ALICATE PELACABLES



Código	Ref.		EAN
5114758	DS4880	160 mm	5602482048805

ALICATE EXTENSIVO ISOLADO

ALICATE DE CREMALLERA ISOLADO



Código	Ref.		EAN
5114571	D2GL250	10" 250 mm	5602482047242

ALICATE PORTA ELECTRODOS

ALICATE PORTA ELECTRODOS



Código	Ref.		EAN
5102783		300 amp.	5602482026520
5102784		500 amp.	5602482026537

ALICATE FIXAÇÃO

MORDAZA GRIP



Alicates de boca curva com corta arame incorporado para uma variedade mais ampla de aplicações e formas de materiais.

Mordazas de boca curva con corta alambres incorporado para una amplia variedad de aplicaciones y formas de materiales.

Código	Ref.		Medida Abertura	EAN
5109639	DS2183/5WR	5" 125 mm	6	5602482021839
5106913	DS1054/7WR	7" 180 mm	6	5602482010543
5106914	DS1055/10WR	10" 250 mm	6	5602482010550
5110547	DS2845/12WR	12" 300 mm	6	5602482028456

ALICATE FIXAÇÃO

MORDAZA GRIP



Facilitam o agarre de placas de metal em trabalhos de fabricação ou modelação

Facilitan la sujeción de planchas de metal en trabajos de fabricación y moldeado.

Código	Ref.	Medida Abertura	EAN
5114750	DS4872	8R 200 mm 78 mm	5602482048720

ALICATE FIXAÇÃO

MORDAZA GRIP



A mordaza inferior proporciona uma força de agarre três vezes maior sem risco de desprendimento ou dano nas peças a apertar

La mordaza inferior proporciona una fuerza de agarre tres veces mayor sin riesgo de desprendimiento o rotura en tuercas de cualquier estilo.

Código	Ref.	Medida Abertura	EAN
5114747	DS4869	10CR 250 mm 48 mm	5602482048690

ALICATE FIXAÇÃO

MORDAZA GRIP



A ampla abertura das mordazas garante uma grande versatilidade e o aperto de grande variedade de formas.

A amplia apertura de la mordaza ofrece una grand versatilidad en la sujeción de gran variedad de formas

Código	Ref.	Medida Abertura	EAN
5114752	DS4874	11R 275 mm 102 mm	5602482048744

ALICATE FIXAÇÃO

MORDAZA GRIP



O alicate de cabeça reta proporciona um contacto máximo com peças quadradas, quadradas ou hexagonais.

La mordaza de cabeza recta proporciona el máximo contacto con piezas planas, cuadradas o hexagonales.

Código	Ref.	Medida Abertura	EAN
5114748	DS4870	7R 175 mm 38 mm	5602482048706
5114749	DS4871	10R 250 mm 48 mm	5602482048713

ALICATE FIXAÇÃO

MORDAZA GRIP



As placas basculantes e pescoço mais alto permitem segurar peças irregulares ou afiadas com mais facilidade

Las placas basculantes y el cuello más profundo permiten sujetar piezas irregulares o afiladas.

Código	Ref.	Medida Abertura	EAN
5114751	DS4873	11SP 275 mm 102 mm	5602482048737

ALICATE REBITAR
REMACHADORA



Para rebites: 2.4 mm | 3.2 mm | 4.0 mm | 4.8 mm

Código	Ref.		EAN
5104497	DPM0063	300 mm	560248200063

ALICATE REBITAR | CABOS LONGOS
REMACHADORA



Para rebites: 2.4 mm | 3.2 mm | 4.0 mm | 4.8 mm | 6.4 mm

Código	Ref.		EAN
5114578	DS-4723	400 mm	5602482047235

ALICATE REBITAR
REMACHADORA



Para rebites: 2.4 mm | 3.2 mm | 4.0 mm | 4.8 mm

Código	Ref.		EAN
5114579	DS-4721	260 mm	5602482047211

ALICATE REBITAR | LAGARTA
REMACHADORA



Para rebites: 2.4 mm | 3.2 mm | 4.0 mm | 4.8 mm | 6.4 mm

Código	Ref.		EAN
5114576	DS-4722	300 mm 800 mm	5602482047228

ALICATE REBITAR
REMACHADORA



Para rebites: 2.4 mm | 3.2 mm | 4.0 mm | 4.8 mm

Código	Ref.		EAN
5114577	DS-4720	260 mm	5602482047204

ALICATE CORTA ARAME
ALICATE CORTA ALLAMBRE



Código	Ref.		EAN
5106608	WD-01	8" 200 mm	5602482008489

ALICATE MINI BICO CHATO

ALICATE MINI BOCA PLANA



Código	Ref.		EAN
5108839	CB1341 150 mm	 6	5602482013414

ALICATE MINI BICO CURVO

ALICATE MINI PUNTA CURVA



Código	Ref.		EAN
5101168	CB2328 150 mm	 6	5602482023284

ALICATE MINI CORTE FRONTAL

ALICATE MINI CORTE FRONTAL





Código	Ref.		EAN
5108841	CB1340 150 mm	 6	5602482013407

CHAVE CANOS T/SUECO 45°

LLAVE SUECA 45°





Código	Ref.		EAN
5106622	1" 25 mm	 6	5602482021693
5106623	1.1/2" 38 mm	 4	5602482021709
5106624	2" 50 mm	 2	5602482021716

CHAVE CANOS T/SUECO 90°

LLAVE SUECA 90°









Código	Ref.		EAN
5106619	1" 25 mm	 6	5602482021723
5106620	1.1/2" 38 mm	 4	5602482021730
5106621	2" 50 mm	 2	5602482021747

CHAVE CRESCENTE GRADUADA

LLAVE AJUSTABLE GRADUADA



Código	Ref.		EAN
5106614	6" 152 mm	 6	5602482009424
5106615	8" 200 mm	 6	5602482013612
5106616	10" 255 mm	 6	5602482013629
5106617	12" 300 mm	 6	5602482013636
5106618	15" 380 mm	 2	5602482013643
5109301	18" 460 mm	 1	5602482010567
5114383	24" 600 mm	 1	5602482046757

CHAVE CRUZETA (GALVANIZADA)

LLAVE EN CRUZ (GALVANIZADA)



Código	Ref.		EAN
5108439	13 / 17 / 19 / 21 mm	 20	5602482005754

CHAVE STILSON EM ALUMÍNIO

LLAVE STILSON EN ALUMÍNIO



Código	Ref.		EAN
5110734	10" 255 mm	6	5602482030473
5110735	12" 300 mm	6	5602482030480
5106921	14" 355 mm	6	5602482021808
5106922	18" 460mm	12	5602482021815
5106923	24" 609 mm	6	5602482021822
5109859	36" 915 mm	4	5602482029330
5114384	48" 1.220 mm	1	5602482046764

CHAVE STILSON RIDGID

LLAVE STILSON RIDGID

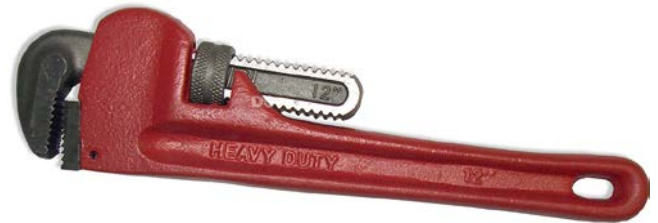

Código	Ref.		EAN
5109565	8" 152 mm		5602482029347
5106915	10" 255 mm	30	5602482004009
5106916	12" 300 mm	24	5602482004016
5106917	14" 355 mm	18	5602482004023
5106918	18" 460mm	12	5602482004030
5106919	24" 609 mm	6	5602482004047
5106920	36" 915 mm	4	5602482018013
5114385	48" 1.220 mm	1	5602482046771

CHAVE STILSON (EXTRA)

LLAVE STILSON (EXTRA)



Código	Ref.		EAN
5109860	10" 255 mm		5602482021754
5109861	12" 300 mm		5602482021761
5109862	14" 355 mm		5602482021778
5109863	18" 460mm		5602482021785
5109864	24" 609 mm		5602482021792
5109865	36" 915 mm		5602482015937

CORTA REBITES

CORTA VARILLAS



Código	Ref.		EAN
5106609	WD-05 14" 355 mm	24	5602482013773
5106610	WD-05 18" 460 mm	12	5602482013148
5106611	WD-05 24" 609 mm	12	5602482018488
5106612	WD-05 30" 762 mm	6	5602482018495
5106613	WD-05 36" 915 mm	4	5602482018501

ROQUETE

LLAVE CARRACA



Código	Ref.		EAN
5114753	DS4875 1/4" (155 mm)	6	5602482048751
5114754	DS4876 3/8" (200 mm)	6	5602482048768
5114755	DS4877 1/2" (250 mm)	6	5602482048775

LÂMINA PARA CORTA REBITES

CUCHILLA PARA CORTA VARILLAS



Código	Ref.		EAN
5108040	WD-05 14" 355 mm	24	5602482016262
5108041	WD-05 18" 460 mm	12	5602482016293
5108042	WD-05 24" 609 mm	12	5602482016804
5108043	WD-05 30" 762 mm	6	5602482017962
5108044	WD-05 36" 915 mm	4	5602482017979

ARRANCA PREGOS

PATA DE CABRA



Código	Ref.		EAN
5114759	DS4881	500 x 18 mm	5602482048812
5114760	DS4882	600 x 18 mm	5602482048829
5114761	DS4883	700 x 18 mm	5602482048836
5114762	DS4884	800 x 18 mm	5602482048843
5114763	DS4885	1.000 x 20 mm	5602482048850

SERROTE FOLHA LARGA UNIVERSAL

SERRUCHO UNIVERSAL



Código	Ref.		EAN
5114648	PSW14/14	350 mm 14"	6-24 5602482047778
5114649	PSW14/16	400 mm 16"	6-24 5602482047785
5114650	PSW14/18	450 mm 18"	6-24 5602482047792
5114651	PSW14/20	500 mm 20"	6-24 5602482047808
5114652	PSW14/22	550 mm 22"	6-24 5602482047815

ARMAÇÃO DE SERRA

ARCO DE SIERRA



Código	Ref.		EAN
5114653	DS4782	305 mm	6-24 5602482047822

CORTA TUBOS

CORTA TUBOS



Código	Ref.		EAN
5114757	DS4879	3 - 30 mm	6-24 5602482048799

ARMAÇÃO DE SERRA

ARCO DE SIERRA



Código	Ref.		EAN
5114692	DS4801	300 mm	6-24 5602482048010

TESOURA PARA TUBOS PLÁSTICO

TIJERA PARA TUBOS PLASTICO



ARMAÇÃO DE SERRA

ARCO DE SIERRA



Código	Ref.		EAN
5114691	DS4800	300 mm	6-24 5602482048003

Código	Ref.		EAN
5114756	DS4878	42 mm	6-24 5602482048782

TESOURA CORTAR CHAPA CORTE À DIREITA

TIJERA CORTA-CHAPAS CORTE A LA DERECHA



Código	Ref.		EAN
5114575	DS-4698 250 mm verde	6	5602482046986

TESOURA CORTAR CHAPA CORTE À ESQUERDA

TIJERA CORTA-CHAPAS CORTE A LA IZQUIERDA



Código	Ref.		EAN
5114574	DS-4697 250 mm vermelha	6	5602482046979

TESOURA CORTAR CHAPA CORTE À RETO

TIJERA CORTA-CHAPAS CORTE A LA RECTO



Código	Ref.		EAN
5114573	DS-4699 250 mm amarela	6	5602482046993

TURQUESA M/RUSSO

TENAZA RUSA



Código	Ref.		EAN
5109643	9" 225 mm	6	5602482012868
5114572	10" 255 mm	6	5602482047259

COLHER ESTUCADOR - CABO MADEIRA

PALETA MODELO NORTE - MANGO MADEIRA



Código	Ref.			EAN
51013570	404.197	200mm	6	5602482045255

COLHER CANTOS CORTADOS - CABO MADEIRA

PALETA MODELO MADRIS - MANGO MADEIRA



Código	Ref.			EAN
5113572	409.009	9" 225 mm	6	5602482045248

MAÇO DE BORRACHA (PRETO)

MARTILLO GOMA (NEGRO)



Código	Ref.			EAN
5110510	316	40 mm	6	5602482011717

MAÇO DE BORRACHA (BRANCO)

MARTILLO GOMA (BLANCO)



Código	Ref.			EAN
5113567	317.040	40 mm	6	5602482045040

MARTELO DE BOLA CROMADO

MARTILLO DE BOLA CROMADO



Código	Ref.			EAN
5105592	305-E	200 grs.	6	5602482008144
5105593	305-E	300 grs.	6	5602482008151
5105594	305-E	500 grs.	6	5602482008809

MARTELO S/AMERICANO CROMADO

MARTILLO CARPINTERO CROMADO



Código	Ref.			EAN
5105588	127	23 mm	6	5602482009004

TALOCHA LISA - CABO PLÁSTICO

LLANA - MANGO PLASTICO



Código	Ref.			EAN
5106584	185-2	130 x 280 mm	12	5602482019072

TESOURA DE RELVA

TIJERA CORTA SETOS



Código	Ref.			EAN
5113573	470.012	12" 300 mm	6	5602482045125

ALMOFADA PARA LIXA (BORRACHA)

TACO PARA LIJA (CAUCHO)



Código	Ref.		EAN
5105251	DPM 2615	120 x 65 mm	5602482026155

CHAVE PARA FILTROS

LLAVE PARA FILTROS ACEITE



Código	Ref.		EAN
5105252	DPM2616		5602482026162

ALMOFADA PARA LIXA

TACO PARA LIJA



Código	Ref.		EAN
5105250	DPM2613	160 x 85 mm	5602482026131
5105249	DPM2614	210 x 105 mm	5602482026148

CHAVE LAVATÓRIO

LLAVE TUERCA PARA LAVABO



Código	Ref.		EAN
5106129	DPM2617		5602482026179

BATEDOR CIMENTO COLA

VARILLA MEZCLADORA

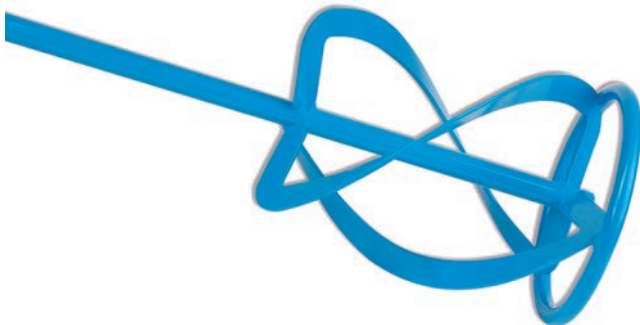

Código	Ref.		EAN
5106809	DPM2590	70 x 400 mm	5602482025905
5101333	DPM2591	100 x 600 mm	5602482025912
5106951	DPM2592	120 x 600 mm	5602482015929

DESENTUPIDOR DE CANOS

DESATASCADOR CON MANIVELA



Código	Ref.		EAN
5106126	040122-1N	3 m	5602482021501
5106127	040123N	5 m	5602482004054
5108269	040124N	10 m	5602482003750

CORTANTE PARA CORTA AZULEJOS

RODELLE PARA CORTADORAS CERAMICAS



Código	Ref.			EAN
5105246	599211-0501	10 mm	12	5602482016392
5105247	599111-501	18 mm	12	5602482016408

CRUZETAS PLÁSTICAS

CRUCETAS PLÁSTICAS



Código	Ref.			EAN
5118719	DPM4093	1 mm (250 un.)	200	5602482040939
5105055	DPM2594	2 mm (250 un.)	200	5602482025943
5105056	DPM2595	3 mm (200 un.)	200	5602482025950
5105057	DPM2596	4 mm (200 un.)	100	5602482025967
5105058	DPM2597	5 mm (200 un.)	100	5602482025974
5110827	DPM3127	6 mm (200 un.)	100	5602482031272
5106130	DPM2598	8 mm (100 un.)	100	5602482025981
5109152	DPM2599	10 mm (100 un.)	100	5602482025998

CUNHAS PLÁSTICAS

CUÑAS PLÁSTICAS



Código	Ref.			EAN
5118012	DPM3128	30 x 6 x 5 mm (100 un.)	70	5602482031289

DIAMANTE A ÓLEO

CORTADOR DE VIDRIO (ACEITE)



Código	Ref.			EAN
5105059	DPM2620		6	5602482026208

JOELHEIRAS (BORRACHA)

RODILLERAS (CAUCHO)



Código	Ref.			EAN
5105523	DPM2600		40	5602482026001

FITA VEDANTE

CINTA TEFLON

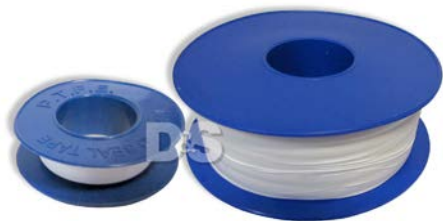

Código	Ref.			EAN
5500733		12 mm x 10 m	12-1200	5602482032064
5500734		25 mm x 50 m	1 - 200	5602482004085

VENTOSA PARA AZULEJOS/VIDROS

VENTOSA PARA CERAMICA/VIDRIOS



Código	Ref.		EAN
5106807	DPM2601	Ø 110 mm	5602482026018

PEDRA AFIAR 2 FACES

PIEDRA AFILAR 2 FACES



Código	Ref.		EAN
5102091	709	150 x 50 x 25 mm	5602482005150
5102092	709	200 x 50 x 25 mm	5602482005167

SERRA CRANENANA DIAMANTADA

CORONA DIAMANTADA



Código	Ref.		EAN
5110816	560110	10 mm	5602482029989
5110817	560112	12 mm	5602482029996

PEDRA AFIAR GADANHAS

PIEDRA AFILAR GUADAÑAS



Código	Ref.		EAN
5104597		225 x 35 x 15 mm	5602482020351

TALOCHA PARA JUNTAS (BORRACHA)

TALOCHA PARA JUNTAS (CAUCHO)



Código	Ref.		EAN
5109546	DPM2621	4" x 9" 100 x 230 mm	5602482026216
5109547	DPM2622	4" x 12" 100 x 300 mm	5602482026223

BROCA CENTRADORA PARA SERRAS CRANEANAS
SUPORTE PARA CORONAS



Código	Ref.		EAN
5105860	10103001 1/4" 6 mm		5602482028067

BROCA CENTRADORA PARA SERRAS CRANEANAS
SUPORTE PARA CORONAS



Código	Ref.		EAN
5105861	10103008 7/16" 11 mm		5602482028074

BROCA PILOTO
BROCA PILOTO



Código	Ref.		EAN
5106177	10104008 para centradoras 1/4" e 7/16"		5602482028050

EXTENSÃO SDS MAX | PARA CRANEANAS SDS
EXTENSION SDS MAX



Código	Ref.		EAN
5114378	268000350 350 mm		5602482046726
5114379	268000450 450 mm		5602482046733

BROCA CRANEANA PASTILHADA
BROCA PUNTA DE CARBURO



Código	Ref.		EAN
5111809	26900030 30 mm	3	5602482041707
5111810	26900035 35 mm	3	5602482041714
5111811	26900040 40 mm	3	5602482041721
5111812	26900045 45 mm	3	5602482041738
5111813	26900050 50 mm	3	5602482041745
5111814	26900055 55 mm	3	5602482041752
5111815	26900060 60 mm	3	5602482041769
5111816	26900065 65 mm	3	5602482041776
5111817	26900070 70 mm	3	5602482041783
5111818	26900075 75 mm	3	5602482041790
5111819	26900080 80 mm	3	5602482041806
5111820	26900085 85 mm	3	5602482041813
5111821	26900090 90 mm	3	5602482041820
5111822	26900095 95 mm	3	5602482041837
5111823	26900100 100 mm	3	5602482041844
5111824	26900105 105 mm	3	5602482041851
5111825	26900110 110 mm	2	5602482041868
5111826	26900120 120 mm	2	5602482041875
5114380	26900130 130 mm		5602482046689
5114381	26900150 150 mm		5602482046696

EXTENSÃO SDS PLUS | PARA CRANEANAS SDS
EXTENSION SDS plus



Código	Ref.		EAN
5114376	267000350 350 mm		5602482046702
5114377	267000450 450 mm		5602482046719

ESCOPRO SDS MAX

CINCEL SDS MAX



Código	Ref.		EAN
5118579	451205	Ø 18 x 25 x 300 mm	5602482047266
5118580	451260	Ø 18 x 25 x 400 mm	5602482047273
5118520	451207	Ø 18 x 25 x 600 mm	5602482047280
5118581	451206	Ø 18 x 50 x 400 mm	5602482047297

ESCOPRO SDS PLUS

CINCEL SDS PLUS



Código	Ref.		EAN
5118574	451242	Ø 14 x 20 x 250 mm	5602482047303
5118575	451221	Ø 18 x 40 x 250 mm	5602482047310

PONTEIRO SDS MAX

PUNTERO SDS MAX



Código	Ref.		EAN
5118576	451201	Ø 18 x 250 mm	5602482047327
5118577	451258	Ø 18 x 400 mm	5602482047334
5118578	451202	Ø 18 x 600 mm	5602482047341

ESCOPRO SDS PLUS

CINCEL SDS PLUS



Código	Ref.		EAN
5118573	451240	Ø 14 x 250 mm	5602482047358

ADAPTADOR PARA BUCHAS SDS PLUS

ADAPTADOR PARA PORTABROCAS SDS PLUS



Código	Ref.		EAN
5112902	26714001	1/2" x 20 UNF	5602482043107

BROCA ESCALONADA HSS

JUEGO DE TERRAJAS

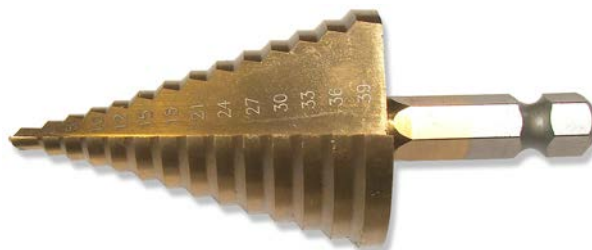

Efetua furos perfeitos em aço, cobre, latão, alumínio, madeira e plástico

Realiza furos perfectos en acero, cobre, latón, aluminio, madera y plástico

Medidas:

9 furos: 4 - 6 - 8 - 10 - 12 - 14 - 16 - 18 - 20 mm

14 furos: 4 - 6 - 8 - 10 - 12 - 15 - 18 - 21 - 24 - 27 - 30 - 33 - 36 - 39 mm

Código	Ref.		EAN
5114606	13009082	Ø 4 a 20 mm 9 furos	4 5602482047389
5110760	13014000	Ø 4 a 39 mm 14 furos	4 5602482029729

PERFURADOR DE CHAPA

PERFORADOR DE CHAPA



Código	Ref.		EAN
5110807	21600032	32 mm	10 5602482047365
5110806	21600035	35 mm	10 5602482047372

FRESA ESCAREADORA

FRESA



Medidas:
6,3/ 8,3/ 10,4/ 12,4/ 16,5/ 20,5 mm

Código	Ref.		EAN
5112878	13500006	6 pcs.	5602482042865

FRESA ESCAREADORA

FRESA



DIN 335
Ideal para fresar diversos tipos de materias, tais como: ferro, aço, plástico ou madeira

DIN 335
Para fresar materiais de: hierro, acero, plastico, madera...

Código	Ref.		EAN
5112876	13600124	12,4 mm espiga 8 mm	5602482042841
5112877	13600190	19 mm espiga 10 mm	5602482042858

FRESA ESCAREADORA

FRESA



Fabricadas em aço carbono para acabamentos de precisão. Para furar madeira dura, cartão prensado e plástico

Fabricadas en acero al carburo para finalización de precision. Para furar madera dura, cartón prensado y plastico.

Código	Ref.		EAN
5112879	48030526	26 x 50 mm espiga 8 mm	5602482042872
5112880	48030530	30 x 50 mm espiga 8 mm	5602482042889
5112881	48030535	35 x 50 mm espiga 8 mm	5602482042896

MACHO HSS

MACHO HSS



Código	Ref.		EAN
5112882	18600030	M 3 (jogo 3 pcs.)	5602482042902
5112883	18600040	M 4 (jogo 3 pcs.)	5602482042919
5112884	18600050	M 5 (jogo 3 pcs.)	5602482042926
5112885	18600060	M 6 (jogo 3 pcs.)	5602482042933
5112886	18600070	M 7 (jogo 3 pcs.)	5602482042940
5112887	18600080	M 8 (jogo 3 pcs.)	5602482042957
5112888	18600100	M10 (jogo 3 pcs.)	5602482042964
5112889	18600120	M12 (jogo 3 pcs.)	5602482042971
5112890	18600140	M14 (jogo 3 pcs.)	5602482042988
5112891	18600160	M16 (jogo 3 pcs.)	5602482042995
5112892	18600180	M18 (jogo 3 pcs.)	5602482043008
5112893	18600200	M20 (jogo 3 pcs.)	5602482043015

DESANDADOR DE MACHOS (COM ROQUETE)

GIRAMACHOS (CON CARRACA)



Código	Ref.		EAN
5112870	19600001	Nº 1 M3 a M10	5602482042780
5112871	19600002	Nº 2 M5 a M12	5602482042797

DESANDADOR DE MACHOS

GIRAMACHOS



Código	Ref.		EAN
5112872	19700010	Nº 0 M1 a M8	5602482042803
5112873	19700020	Nº 1 M3 a M10	5602482042810
5112874	19700040	Nº 2 M4 a M12	5602482042827
5112875	19700050	Nº 3 M5 a M20	5602482042834

SERRA CRANEANA BIMETAL
CORONA BIMETAL



Código	Ref.		Quantidade	EAN
5105826	10101014	14 mm	10	5602482029163
5105827	16101016	16 mm	10	5602482028852
5105828	10101019	19 mm	10	5602482028340
5105829	10101022	22 mm	10	5602482028098
5105830	10101025	25 mm	10	5602482028104
5105831	10101028	28 mm	10	5602482028111
5105832	10101032	32 mm	10	5602482028128
5105833	10101035	35 mm	10	5602482028135
5105834	10101038	38 mm	10	5602482028142
5105835	10101041	41 mm	10	5602482029170
5105836	10101044	44 mm	10	5602482028159
5105837	10101048	48 mm	10	5602482028166
5105838	10101051	51 mm	10	5602482028746
5105839	10101054	54 mm	10	5602482028173
5105840	10101057	57 mm	10	5602482029187
5105841	10101060	60 mm	10	5602482028869
5105842	10101064	64 mm	10	5602482028180
5105843	10101067	67 mm	10	5602482028197
5105844	10101070	70 mm	10	5602482028876
5105845	10101073	73 mm	10	5602482028203
5105846	10101086	76 mm	10	5602482028883
5105847	10101079	79 mm	10	5602482028210
5105848	10101083	83 mm	10	5602482028227
5105849	10101086	86 mm	10	5602482029194
5105850	10101089	89 mm	5	5602482029200
5105851	10101092	92 mm	5	5602482029217
5105852	10101095	95 mm	5	5602482029224
5105853	10101098	98 mm	5	5602482029231
5105854	10101102	102 mm	5	5602482028234
5105855	10101108	108 mm	5	5602482028845
5105856	10101114	114 mm	5	5602482028890
5105857	10101121	121 mm	5	5602482028241
5105858	10101127	127 mm	5	5602482028258
5114894	10101133	133 mm		5602482050150
5114895	10101140	140 mm		5602482050167
5114896	10101146	146 mm		5602482050174
5114897	10101152	152 mm		5602482050181
5114898	10101160	160 mm		5602482050198
5114899	10101165	165 mm		5602482050204
5104900	10101168	168 mm		5602482050211
5114901	10101178	178 mm		5602482050228
5114902	10101200	200 mm		5602482050235

SERRA CRANEANA PARA MADEIRA
CORONAS PARA MADEIRA



Composição: 8 serras craneanas (19 a 64 mm) / 2 brocas centradoras / 1 pua 3 bicos (25 mm) / 1 chave t/umbrako
Composición: 8 coronas (19 a 64 mm) / 2 suportes coronas / 1 broca plana (25 mm) / 1 llave allen

Código	Ref.	Quantidade	EAN
5112894	56100013	13 pcs. 19 a 64 mm	5602482043022

SERRA CRANEANA PARA MADEIRA
CORONAS PARA MADEIRA



Composição: 12 serras craneanas (19 a 127 mm) / 2 brocas centradoras / 1 chave t/umbrako
Composición: 12 coronas (19 a 127 mm) / 2 suportes coronas / 1 llave allen

Código	Ref.	Quantidade	EAN
5114982	56100016	16 pcs. 19 a 127 mm	5602482050648

SERRA CRANEANA BIMETAL
CORONA BIMETAL



Composição: 11 serras craneanas (19 a 76 mm), 2 brocas centradoras (1/4" e 7/16", 1 adaptador
Composición: 11 coronas (19 a 76 mm), 2 suportes coronas (1/4" y 7/16"), 1 adaptador

Código	Ref.	Quantidade	EAN
5105859	10105012	14 pcs. 19 a 76 mm	5602482028081

SERRA CRANEANA

SIERRA



Medidas:
25, 32, 38, 45, 50, 56 e 62 mm

Código	Ref.		EAN
5110639	56100007	25 mm (7 lâminas)	5602482030428
5110640	56101007	50 mm (7 lâminas)	5602482030435

TARRAXA

JUEGO DE TERRAJAS



Código	Ref.		EAN
5104868	1/2" a 1.1/4"	4	5602482015531

SERRA CRANEANA TUNGSTÊNIO

CORONA PARA CERÂMICA



Composição:
8 serras craneanas (33 a 103 mm), 1 broca piloto+suporte

Composição:
11 coronas (33 a 103 mm), 1 broca piloto+suporte

Código	Ref.		EAN
5110857	9 pcs. 33 a 103 mm)		5602482030442

CABEÇAS PARA TARRAXAS

CABEZAS PARA TERRAJAS



Código	Ref.		EAN
5104870	3/4"		5602482024564
5104869	1/2"		5602482024557
5104871	1"		5602482024540
5104872	1.1/4"		5602482024533

BOINA POLIR | LÃ

BONETE DE LANA



Código	Ref.		EAN
5114981	61202102	Ø 125 mm	5602482050464
	61202104	Ø 180 mm	5602482052538

PERNOS DE MADEIRA

ESPIGAS PARA ENSAMBLAR



Código	Ref.		EAN
5114904	29050000	Ø 6 x 30 mm 100 unid.	5602482050594
5114905	29070000	Ø 8 x 40 mm 100 unid.	5602482050600
5114906	29090000	Ø 10x40 mm 100 unid.	5602482050617

BROCA VIDRO/CERÂMICA

BROCA PARA VIDRIO E CERAMICA



Código	Ref.		EAN
5114965	26400108	3 x 60mm	5602482050471
5114966	26400532	4 x 60 mm	5602482050488
5114967	26400316	5 x 60 mm	5602482050495
5114968	26400104	6 x 70 mm	5602482050501
5114969	26400516	8 x 80 mm	5602482050518
5114970	26400308	10 x 85 mm	5602482050525
5114971	26401532	12 x100 mm	5602482050532

MÓS SORTIDAS

MUELAS SORTIDAS



Código	Ref.		EAN
5114907	19500005	haste 6 mm 5 pcs.	5602482050730

MÓS SORTIDAS

MUELAS SORTIDAS



Código	Ref.		EAN
5114908	19500010	haste 6 mm 10 pcs.	5602482050747

BROCAS SDS PLUS

BROCAS SDS PLUS

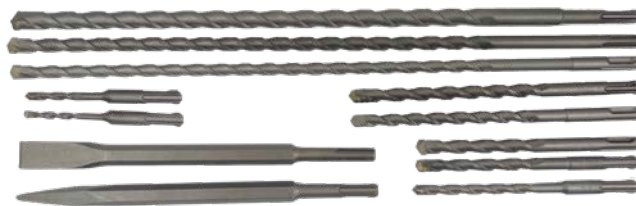

10 brocas: 5 e 6x110mm; 8, 10 e 12x160mm:
10 e 12x210mm; 10, 12 e 16x450mm
Ponteiro: 250 mm - Escopro: 20x250mm

10 brocas: 5 y 6x110mm; 8, 10 y 12x160mm:
10 y 12x210mm; 10, 12 y 16x450mm
Puntero: 250 mm - Cíncel: 20x250mm

Código	Ref.		EAN
5116058	26000012	12 unidades	5602482050549

PUNÇÕES

JUEGO DE BOTADORES



Punções:
9.5x2x150mm / 9.5x3x150mm /
9.5x4x150mm / 9.5x5x150mm /
12x6x150mm / 12x8x150mm

Botadores:
9.5x2x150mm / 9.5x3x150mm /
9.5x4x150mm / 9.5x5x150mm /
12x6x150mm / 12x8x150mm

Código	Ref.		EAN
5114972	50100006	6 pcs.	5602482050324

PUNÇÕES + ESCOPROS

BOTADORES + CORTAFRIOS



Escopro: 12x130mm e 15x150mm
Punção: 3x120mm
Punção cónico: 3x120mm, 4x150mm
Cíncel: 4x130 mm

Cortafrio: 12x130mm e 15x150mm
Botador: 3x120mm
Botador cónico: 3x120mm, 4x150mm
Cíncel: 4x130 mm

Código	Ref.		EAN
5114973	50110007	6 pcs.	5602482050631

MACACOS HIDRÁULICOS (GARRAFA)

GATOS HIDRAULICOS (BOTELLA)

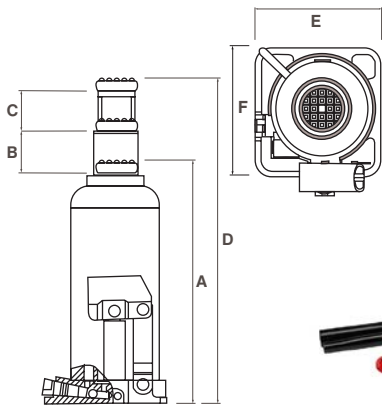

Referencia	TH90204S	TH90304S	TH90504S	TH90804	TH91004	TH91204	TH91504	TH92004	TH93004	TH95007
Código	5105901	5105902	5105903	5105904	5105905	5105906	5105907	5105908	5107826	5107827
Capacidade	2 toneladas	3 toneladas	5 toneladas	8 toneladas	10 toneladas	12 toneladas	15 toneladas	20 toneladas	30 toneladas	50 toneladas
A	168 mm	188 mm	207 mm	222 mm	222 mm	230 mm	230 mm	240 mm	260 mm	280 mm
B	108 mm	115 mm	125 mm	145 mm	145 mm	150 mm	150 mm	150 mm	160 mm	170 mm
C	48 mm	60 mm	70 mm	80 mm	80 mm	80 mm	80 mm	60 mm	-	-
D	316 mm	363 mm	42 mm	447 mm	450 mm	460 mm	460 mm	450 mm	420 mm	450 mm
E x F (mm)	94.5 x 78	108.5 x 87	117 x 97	124 x 106	124 x 106	134.5 x 115	141 x 118	160 x 140	185 x 165	207 x 185
Embalagem	6	6	4	4	4	3	2	2	1	1
EAN	6922539896319	6922539896296	692253986302	6922539896210	6922539896227	6922539896234	6922539896241	6922539896265	6922539896272	6922539896289

MACACO DE GARAGEM - REBAIXADO

GATO HIDRAULICO CON RUEDAS



Características

Capacidade	2,5 toneladas
Altura mínima	87 mm
Altura máxima	455 mm
Peso	33 kg
Medidas	640 x 342 x 175 mm

Código	Ref.		EAN
5114857	TZ830018	2,5 toneladas	6922539883180

MACACO DE GARAGEM

GATO HIDRAULICO CON RUEDAS



Características

Capacidade	2 toneladas
Altura mínima	130 mm
Altura máxima	350 mm
Peso	10,5 kg
Medidas	500 x 200 x 125 mm

Código	Ref.		EAN
5105919	T82004S	2 toneladas	6922539882244

MACACO DE GARAGEM

GATO HIDRAULICO CON RUEDAS



Características

Capacidade	2.1/4" toneladas
Altura mínima	145 mm
Altura máxima	520 mm
Peso	36,5 kg
Medidas	695 x 344 x 180 mm

Código	Ref.			EAN
5105909	T82257	2.1/4" toneladas	1	5602482018037

MACACO DE GARAGEM COM EXTENSÃO

GATO HIDRAULICO CON RUEDAS



Características

Capacidade	2,5 / 3 toneladas
Altura mínima	150 mm
Altura máxima	530 mm
Peso	19 kg / 21 kg
Medidas	640 x 230 x 220 mm

Código	Ref.			EAN
5114858	T83006B	2,5 toneladas	1	6922539882138
5106607	T83006B	3 toneladas	1	5602482029149

MACACO DE GARAGEM - ELEVAÇÃO RÁPIDA

GATO HIDRAULICO CON RUEDAS



Características

Capacidade	3 toneladas
Altura mínima	145 mm
Altura máxima	500 mm
Peso	38 kg
Medidas	685 x 346 x 180 mm

Macaco de garagem com pedal de aproximação rápida à carga a levantar. Gato hidráulico con pedal de aproximación rápida a la carga.

Código	Ref.			EAN
5106170	T83502	3 toneladas	1	6922539883050

BOMBA TRASFEGA

BOMBA DE TRASVASE



Tubo de aspiração: 980 mm

Tubo aspiración: 980 mm

Código	Ref.		EAN
5106795	caudal: 30 lit./minuto	5	5602482013605

ESTOJO CHAPEIRO

ESTUCHE PARA LATONERO



Código	Ref.		EAN
5106783	7 pcs.	4	5602482018709

ESTICADOR

TENSOR



Código	Ref.		EAN
5105910	TR8020 2 ton. cabo: 4 m x Ø 5 mm	6	5602482006102
5105911	TR8041 4 ton. cabo: 4 m x Ø 5 mm	4	5602482008205

GARIBALDE MANUAL

POLIPLASTO



Referencia	HSZ-0,5T	HSZ-1T	HSZ-2T
Código	5105916	5105917	5101052
Capacidade	0,5 ton.	51010521 ton.	2 ton.
Altura levantamento padrão	2,5 m	2,5 m	2,5 m
Teste de carga (máx.)	0,75 ton.	1,5 ton.	3 ton.
Altura mínima (gancho a gancho)	270 mm	270 mm	444 mm
Tensão (N)	225	309	314
Comprimento corrente	3 m	3 m	3 m
Diâmetro corrente	6 mm	6 mm	6 mm
Nº voltas de corrente	1	1	2
Peso líquido	9,5 kg	10 kg	14 kg
EAN	5602482021174	5602482021181	5602482017788

MESA MATÁLICA PARA FERRAMENTAS
CARRO TALLER METALICO



Medidas:
Mesa: 737x383x663 mm
Tabuleiros: 735x380x85 mm

Medidas:
Mesa: 737x383x663 mm
Bandejas: 735x380x85 mm

Código	Ref.		EAN
5105915	TC302	capacidade carga: 136 kg	5602482020962

PRENSA PARA CHAPEIROS
EQUIPO DE CARROCERO



Código	Ref.		EAN
5105918	T71001S	10 toneladas	5602482009233

TINA PARA LAVAR PEÇAS | 5 GALÕES
TINA PARA LAVAR PIEZAS | 5 GALONES

NOVO



Características:
Cesto lavagem: 430x340x220 mm
Capacidade: 19 litros
Solvente: 13 litros
Débito bomba: 2.7/3.3 lit./min.
Medidas: 470x360x250 mm
Peso: 6,5 kg

Características:
Cesto lavado: 430x340x220 mm
Capacidade: 19 litros
Solvente: 13 litros
Caudal de la bomba: 2.7/3.3 lit./min.
Medidas: 470x360x250 mm
Peso: 6,5 kg

Código	Ref.		EAN
5118824	DS5468G5	capacidade: 5 gal. 19 lit.	5602482054684

TINA PARA LAVAR PEÇAS | 20 GALÕES
TINA PARA LAVAR PIEZAS | 20 GALONES



Características:
Cesto lavagem: 760x520x300 mm
Capacidade: 75 litros
Solvente: 45 litros
Débito bomba: 2.7/3.3 lit./min.
Medidas: 790x550x320 mm
Peso: 28 kg

Características:
Cesto lavado: 760x520x300 mm
Capacidade: 75 litros
Solvente: 45 litros
Caudal de la bomba: 2.7/3.3 lit./min.
Medidas: 790x550x320 mm
Peso: 28 kg

Código	Ref.		EAN
5101271	DS3533G20	capacidade: 20 gal. 75 lit.	5602482035331

PORTA PALETES MANUAL

TRANSPALETA MANUAL



Características

Capacidade	2.500 kg
Elevação total	200 mm
Comprimento garfos	1.150 mm
Largura entre garfos	525 mm
Ø rodas giratórias	200 x 45 mm
Ø rodas dos garfos	82 x 6 0 mm
Peso	63 kg

Sistema hidráulico. Ligação esférica entre a direção do veio e o pistão da bomba. Fácil de manobrar num raio de 210 graus.
Válvula especial de abaixamento para controlar a taxa de descida, e válvula de sobrecarga para tornar este porta paletes mais resistente e durável.
Curso do elevador em altura (por cada movimento: elevação de 12 mm).

Sistema hidráulico. Conexión esférica entre el manillar y el pistón de la bomba. De fácil manejo en un radio de 210 grados.
Válvula especial de descenso para controlarlo y válvula de sobrecarga que hace este modelo mas resistente.
Para cada accionamiento de la palanca se puede regular una elevación de 12 mm

Código	Ref.		EAN
5114498	GS25S4 2,5 TONELADAS	1	5602482029125

GRUA HIDRAULICA DOBRÁVEL

GRUA HIDRAULICA PLEGABLE



Características

Capacidade	1 tonelada
Elevação	25 ~2.040 mm
Comprimento	1.510 mm
Largura	1.015 mm
Altura	1.545 mm
Carga nominal	250/500/750/1.000 kg
Comp. braço	1.250/1.160/1.070/980 mm
Altura mínima	178 mm
Peso	65 kg

Este produto foi especialmente desenhado para elevar, baixar e transportar com o mínimo esforço motores, diferenciais, transmissões e outras cargas pesadas.
• Braço de elevação regulável.
• Armação tubular em aço de grande espessura.
• Dobrável para mais fácil armazenamento.

Este producto está especialmente diseñado para elevar, bajar y transportar motores, diferenciales, transmisiones y otras cargas pesadas con el mínimo esfuerzo.
• Brazo de elevación regulable.
• Construcción tubular de acero de gran espesor.
• Plegable para un fácil almacenamiento.

Código	Ref.		EAN
5114237	T31002X-GS 1 tonelada	1	5602482029132

GROSA MEIA CANA - CABO BORRACHA

RASPA MEDIA CAÑA - MANGO BIMATERIA



Para limar superfícies côncavas em madeira, plásticos... Para trabajar superficies côncavas en madera, plásticos...

Código	Ref.		EAN
5110646	0313-150-1 6" 150 mm BASTARDO	6	5602482029859
5110647	0313-200-1 8" 200 mm BASTARDO	6	5602482029866
5110648	0313-250-1 10" 255 mm BASTARDO	6	5602482029873
5110649	0313-300-1 12" 300 mm BASTARDO	6	5602482029880

LIMA PARALELA - CABO BORRACHA

LIMA PARALELA - MANGO BIMATERIA



Para limar superfícies planas e cantos vivos. Para limar superficies plana y cantos vivos.

Código	Ref.		EAN
5101065	0111-150-1 6" 150 mm BASTARDO	6	5602482022317
5101066	0111-200-1 8" 200 mm BASTARDO	6	5602482022324
5114253	0111-250-1 10" 250 mm BASTARDO	6	5602482046450
5101319	0111-150-3 6" 150 mm MURÇO	6	5602482022348
5101320	0111-200-3 8" 200 mm MURÇO	6	5602482022355
5101321	0111-250-3 10" 250 mm MURÇO	6	5602482022362

LIMA MEIA CANA - CABO BORRACHA

LIMA MEDIA CAÑA - MANGO BIMATERIA



Para limar superfícies côncavas e grandes furos. Para limar superficies côncavas y agujeros grandes.

Código	Ref.		EAN
5101056	0113-150-1 6" 150 mm BASTARDO	6	5602482022225
5101057	0113-200-1 8" 200 mm BASTARDO	6	5602482022232
5101058	0113-250-1 10" 250 mm BASTARDO	6	5602482022249
5114246	0113-150-3 6" 150 mm MURÇO	6	5602482046375
5114247	0113-200-3 8" 200 mm MURÇO	6	5602482046382
5114248	0113-250-3 10" 250 mm MURÇO	6	5602482046399

LIMA TRIANGULAR EXTRA FINO - CABO BORRACHA

LIMA TRIANGULAR EXTRA FINO - MANGO BIMATERIA



Para limar superfícies côncavas e grandes furos em madeira, plásticos... Para trabajar superficies côncavas en madera, plásticos...

Código	Ref.		EAN
5114254	0223-100-2 4" 100 mm	6	5602482022379

LIMA CHATA - CABO BORRACHA

LIMA PLANA DE PUNTA - MANGO BIMATERIA



Para limar superfícies planas e cantos vivos, mais eficaz em zonas de difícil acesso. Para limar superficies plana y cantos vivos, mejor en partes de difícil acceso.

Código	Ref.		EAN
5114249	0112-150-1 6" 150 mm BASTARDO	6	5602482022256
5101060	0112-200-1 8" 200 mm BASTARDO	6	5602482022263
5114250	0112-250-1 10" 250 mm BASTARDO	6	5602482022270
5114251	0112-150-3 6" 150 mm MURÇO	6	5602482022287
5101315	0112-200-3 8" 200 mm MURÇO	6	5602482022294
5114252	0112-250-3 10" 250 mm MURÇO	6	5602482022300

LIMA TRIANGULAR TIPO FINO - CABO BORRACHA

LIMA TRIANGULAR TIPO FINO - MANGO BIMATERIA



Para afilar serras com dentes obliquos (60°). Para afilar sierras con dientes de tallado obliquo (60°).

Código	Ref.		EAN
5101072	0222-100-2 4" 100 mm	6	5602482022386
5101073	0222-125-2 5" 125 mm	6	5602482022393

LIMA TRIANGULAR REGULAR - CABO BORRACHA

LIMA TRIANGULAR REGULAR - MANGO BIMATERIA



Para afiar serras com dentes obliquos (60°).

Para afilar sierras con dientes de tallado obliquo (60°).

Código	Ref.		EAN
5101074	0221-100-2	4" 100 x 9 mm	5602482022416
5114255	0221-125-2	5" 125 mm	5602482046498
5101076	0221-150-2	6" 150 mm	5602482022430
5101077	0221-175-2	7" 175 mm	5602482022447
5101078	0221-200-2	8" 200 mm	5602482022454

LIMAS CALADO

LIMAS AGUJERO/RELOJERO



Código	Ref.		EAN
5110731	S204-12	12 pcs. 160 mm	5602482029897

LIMATÃO REDONDO

LIMA REDONDA



Código	Ref.		EAN
5101082	0116-150-1	6" 150 mm BASTARDO	5602482022492
5101083	0116-200-1	8" 200 mm BASTARDO	5602482022508
5101084	0116-250-1	10" 250 mm BASTARDO	5602482022515
5101322	0116-150-3	6" 150 mm MURÇO	5602482022461
5101323	0116-200-3	8" 200 mm MURÇO	5602482022478
5114256	0116-250-3	10" 250 mm MURÇO	5602482046511

BOMBA DE PÉ PROFISSIONAL

BOMBIN DE PIE DOBLE PROFESSIONAL



CABO PARA BATERIAS

CABLE ARRANQUE



Características do cabo:
100 amp. / Ø 9 mm / Comprimento 2,20 mt.

Características do cabo:
400 amp. / Ø 10 mm - Comprimento 3,30 mt.

Código	Ref.		EAN
5112980	801E	com manómetro	5602482042773

Código	Ref.		EAN
5106964	100 amp	20	5602482001831
5106965	400 amp	10	5602482012899
5114230	600 amp	5	5602482046344

BOMBA DE PÉ DUPLA

BOMBIN DE PIE DOBLE



FERRO SOLDAR ELÉTRICO

SOLDADOR ELÉCTRICO



Código	Ref.		EAN
5105262	903B	com manómetro	5602482010307

Código	Ref.		EAN
5106970	CDD-D30	30 watt	5602482015258
5106971	CDD-D45	45 watt	5602482008267
5106972	CDD-D60	60 watt	5602482009226
5106973	CDD-D80	80 watt	5602482018518
5114472	CDD-D100	100 watt	5602482046788

FERRO SOLDAR TIPO PISTOLA

PISTOLA SOLDADURA



Pistola dotada com uma ponteira inox intermutável com tempo de aquecimento de 3-8 segundos. Esta pistola foi concebida para uso intermitente de 12 segundos por cada minuto, de acordo com as normas internacionais (12s/48s T25E).

Pistola dotada con una punta inoxidable e intercambiable con un tiempo de calentamiento de 3-8 segundos. Esta pistola fué concebida para un uso intermitente de 12 segundos por cada minuto, de acuerdo con las normas internacionales (12s/48s T25/E)

Características:
Potência: 230 v
Frequência: 50 Hz
Grau de isolamento: II

Características:
Volt: 230
Frecuencia: 50 Hz
Grado de aislamiento: II

Código	Ref.		EAN
5106969	KL-818	100 watt	5602482008779

PISTOLA DE COLAR

PISTOLA DE COLA TERMOFUSIBLE



Pistola de colar para utilização nos mais variados fins, como por exemplo: colagem de flores artificiais, decoração, brinquedos e maquetes, carpintaria, revestimento de alcatifas...
Tempo de aquecimento 3 a 5 segundos com fluxo de cola de 25 a 36 gr./min.

Pistola de colar para su uso en diversos fines, tales como: collage de flores artificiales, decoración, juguetes y modelos, carpintería, alfombras para pisos
Tempo de calentamiento 3 a 5 minutos con flujo de cola de 26 a 36 gr./min.

Código	Ref.		EAN
5112863	FL-288	180 watt	5602482008861

PISTOLA DE COLAR

PISTOLA DE COLA TERMOFUSIBLE



Pistola de colar para utilização nos mais variados fins, como por exemplo: colagem de flores artificiais, decoração, brinquedos e maquetes, carpintaria, revestimento de alcatifas...

Pistola de pegamento para su uso en diversos fines, tales como: collage de flores artificiales, decoración, juguetes y modelos, carpintería, alfombras para pisos

Código	Ref.		EAN
5114127	FL-158	40 watt	5602482005495

PISTOLA DE COLAR PROFISSIONAL

PISTOLA DE COLA TERMOFUSIBLE



Pistola de colar eletrónica com regulação e visor de temperatura. Fornecida com suporte para a pistola, dois bicos, bastões de cola e mala plástica de transporte. Ideal para trabalhos de bricolage e trabalhos de colagem em geral.

Pistola de colar eletrónica con regulación de temperatura. Suministro con soporte para la pistola, barras de cola termifusible, y maleta de transporte. Ideal para trabalos de bricolaje y trabajos de collage en general.

Código	Ref.		EAN
5112864	FL-277	125 watt	5602482042681

COLA TERMOFUSÍVEL

COLA TERMOFUSIBLE



Código	Ref.			EAN
5104312	DPM2609	6 unidades	40	5602482026094
5104313	dpm2610	12 unidades	40	5602482026100

COLA TERMOFUSÍVEL

COLA TERMOFUSIBLE



Código	Ref.			EAN
5500584	GS130MD			5602482029255

TRAÇADOR DE RETAS

PLOMADA TRAZADORA



Traçador metálico com 30 metros de fio e frasco com 50 grs. de pó azul Plomada trazadora metálica com 30 metros de hilo y botella con 50 gramos de polvo azul.

Código	Ref.			EAN
5109559			10	5602482005648

PROJECTOR COM SUPORTE

PROYECTOR CON SUPORTE



Projector com suporte metálico, difusor em plástico e 2 lâmpadas fluorescentes.

Características:
 Tipo lâmpada: 2 G10
 Cabo elétrico: H05RN-F 3x0,75 mm²
 Comprimento cabo: 1,5 metro
 Classe isolamento: IP44

Proyector con soporte metálico, difusor de plástico y 2 lámparas fluorescentes.

Características:
 Tipo lampara: 2 G10
 Cable eléctrico: H05RN-F 3 x 0,75 mm²
 Longitud cable: 1,5 metros
 Classe aislamiento: IP44

Código	Ref.			EAN
5110840	KM0501318	2 x 27 watt		5602482030237

VERIFICADOR DE TENSÃO

DETECTOR DE TENSION



Código	Ref.			EAN
5108917	6895B	10 em 1	20	5602482006409

ALICATE DE MASSA

ALICATE MASA



Código	Ref.		EAN
5108469	200 amperes	50	5602482021556

ALICATE DE MASSA

ALICATE MASA



Código	Ref.		EAN
5108470	350 amperes	50	5602482021563

PINÇA PARA CABOS BATERIAS

PINZAS PARA BATERIAS



Código	Ref.		EAN
5108471	(-) preto negro	100	5602482022003
5108476	(+) vermelho rojo	100	5602482022638

SUPORE PARA BERBEQUIM

SUPORE PARA TALADRO



Código	Ref.		EAN
5112896	80900043 altura: 430 mm curso: 50 mm		5602482043046

SUPORE PARA REBARBADORA

SUPORE PARA AMOLADORA



Código	Ref.		EAN
5112897	96214 para 115 125 150 mm		5602482043053
5112898	96216 para 180 e 230		5602482043060

CHAVE 2 BOCAS (CROMO VANADIUM)

LLAVE FIJA 2 BOCAS (CROMO VANADIUM)



Código	Ref.		EAN
5108989	6 pcs. 6x7 a 16x17 mm	5	5602482022683
5106205	8 pcs. 6x7 a 20x22 mm	5	5602482021570
5108990	10 pcs. 6x7 a 24x27 mm	4	5602482022690
5106206	12 pcs. 6x7 a 30x32 mm	4	5602482021587

CHAVE LUNETA (CROMO VANADIUM)

LLAVE ESTRELLA ACODADA (CROMO VANADIUM)



Código	Ref.		EAN
5108991	6 pcs. 6x7 a 16x17 mm	5	5602482022706
5106207	8 pcs. 6x7 a 20x22 mm	5	5602482021594
5108992	10 pcs. 6x7 a 24x27 mm	5	5602482022713
5106208	12 pcs. 6x7 a 30x32 mm	4	5602482021600

CHAVE 2 BOCAS (CROMO VANADIUM)

LLAVE FIJA 2 BOCAS (CROMO VANADIUM)



Código	Ref.		EAN
5108967	6 x 7 mm	25	5602482007635
5108968	8 x 9 mm	25	5602482006485
5108969	10 x 11 mm	25	5602482006492
5108970	12 x 13 mm	20	5602482006508
5108971	14 x 15 mm	10	5602482006515
5108972	16 x 17 mm	10	5602482006522
5108973	18 x 19 mm	10	5602482006539
5108974	20 x 22 mm	10	5602482006546
5108975	21 x 23 mm	10	5602482006553
5108993	24 x 26 mm	10	5602482006560
5108973	25 x 28 mm	10	5602482006577
5108977	30 x 32 mm	10	5602482006591

CHAVE LUNETA (CROMO VANADIUM)

LLAVE ESTRELLA ACODADA (CROMO VANADIUM)



Código	Ref.		EAN
5108978	6 x 7 mm	25	5602482006607
5108979	8 x 9 mm	25	5602482006614
5108980	10 x 11 mm	20	5602482006621
5108981	12 x 13 mm	20	5602482006638
5108982	14 x 15 mm	20	5602482006645
5108983	16 x 17 mm	20	5602482006652
5108984	18 x 19 mm	10	5602482006669
5108985	20 x 22 mm	10	5602482006676
5108986	21 x 23 mm	10	5602482006683
5108987	24 x 26 mm	10	5602482006690
5108988	25 x 28 mm	5	5602482006642
5108995	27 x 32 mm	5	5602482006659
5113313	30 x 32 mm		5602482044753

CHAVE BOCA/LUNETA (CROMO VANADIUM)

LLAVE COMBINADA (CROMO VANADIUM)

CHAVE BOCA/LUNETA (CROMO VANADIUM)

LLAVE COMBINADA (CROMO VANADIUM)



Código	Ref.	EAN
5110650	8 pcs. 8 a 19 mm	5 5602482029736
5110645	17 pcs. 6 a 22 mm	4 5602482029743
5110644	25 pcs. 6 a 32 mm	2 5602482029750

Código	Ref.	EAN
5101203	6 mm	10 5602482017610
5101204	7 mm	10 5602482017627
5101205	8 mm	10 5602482017634
5101206	9 mm	10 5602482017641
5101207	10 mm	10 5602482017658
5101208	11 mm	10 5602482017665
5101209	12 mm	10 5602482017672
5101210	13 mm	10 5602482017689
5101211	14 mm	10 5602482017696
5101212	15 mm	10 5602482017702
5101213	16 mm	10 5602482017719
5101214	17 mm	10 5602482017726
5101217	18 mm	10 5602482017733
5101220	19 mm	10 5602482017740
5101221	20 mm	10 5602482023475
5101222	21 mm	10 5602482023482
5101223	22 mm	10 5602482023499
5101225	23 mm	10 5602482023505
5101226	24 mm	10 5602482023512
5101227	25 mm	10 5602482023529
5101228	26 mm	10 5602482023536
5101231	27 mm	5 5602482023543
5101232	28 mm	5 5602482023550
5101233	29 mm	5 5602482023567
5101234	30 mm	5 5602482023574
5101235	32 mm	5 5602482023598



CHAVE TUBULAR

LLAVE TUBO



CHAVE TUBULAR (CROMO VANADIUM)

LLAVE TUBO (CROMO VANADIUM)



Código	Ref.		EAN
5113309	14 x 15 mm	25	5602482044548
5113310	16 x 17 mm	20	5602482044555
5113311	18 x 19 mm	20	5602482044562
5113312	20 x 22 mm	10	5602482044579

Código	Ref.		EAN
5118498	8 pcs. 6x7 a 20x22 mm	4	5602482038813

CHAVE TUBULAR

LLAVE TUBO



Código	Ref.		EAN
5118485	6 x 7 mm	20	5602482038820
5118486	8 x 9 mm	20	5602482038837
5118487	10 x 11 mm	25	5602482038844
5118488	12 x 13 mm	25	5602482038851
5118489	14 x 15 mm	25	5602482038868
5118490	16 x 17 mm	15	5602482038875
5118491	18 x 19 mm	10	5602482038882
5118492	20 x 22 mm	10	5602482038899
5118492	21 x 23 mm	10	5602482038905
5118494	24 x 26 mm	10	5602482038912
5118495	25 x 28 mm	10	5602482038929
5114712	27 x 32 mm	10	5602482049918
5118497	30 x 32 mm	10	5602482038943

ARRANCA PREGOS

PATA DE CABRA



Código	Ref.		EAN
5114694	DS4324	300 x ø 12 mm	5602482043244
5114695	DS4325	300 x ø 14 mm	5602482043251

BOLSA PARA FERRAMENTAS EM PELE

BOLSA PARA HERRAMINETAS EN PIEL



Código	Ref.		EAN
5114698	DS1176	2 bolsos 2 bolsillos	5602482011762

BERBEQUIM BLINDADO

BERBEQUIM BLINDADO



Código	Ref.		EAN
5106209	DS3316		5602482033160
5106210	DS2042		5602482020429

BOLSA PARA PREGOS EM PELE

BOLSA PARA CLAVOS EN PIEL



Código	Ref.		EAN
5114697	DS1177	5 bolsos 5 bolsillos	5602482011779

BOLSA PARA FERRAMENTAS EM PELE

BOLSA PARA HERRAMINETAS EN PIEL



Código	Ref.		EAN
5114696	DS1175	11 bolsos 11 bolsillos	5602482011755

GRAMPO DE COFRAGEM

CLAVO SUJECCION PARA ENCOFRADO



Código	Ref.		EAN
5106602	DS2028	250 mm	5602482020283

GRAMPO COM FUSO

TORNILLO DE BANCO

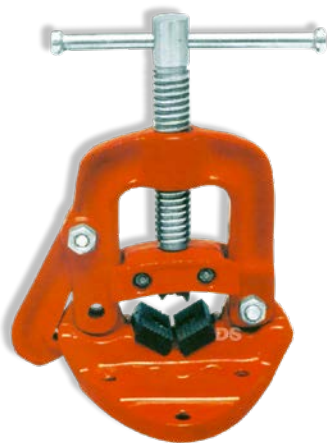

Código	Ref.		EAN
5108618	DS2090	2" 50 mm	56024820290

GRAMPO COM CORRENTE

TORNILLO DE CADENA



Código	Ref.		EAN
5104590		2" 50 mm	5602482011502

PLAINA

CEPILLO CARPINTERO

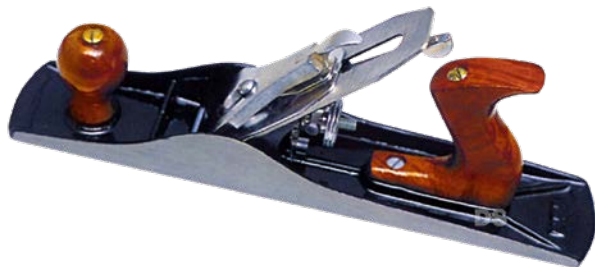

Código	Ref.		EAN
5104585	DS1097	Nº 3 200 mm	5602482010970
5104586	DS1098	Nº 4 225 mm	5602482010987
5104587	DS1099	Nº 5 350 mm	5602482010994

PLAINA

CEPILLO CARPINTERO



Código	Ref.		EAN
5104588	DS1095	140 mm	5602482010956
5104589	DS1096	175 mm	5602482010963

SACA ROLAMENTOS (2 PERNOS)

EXTRACTOR UNIVERSAL (2 GARRAS)



Código	Ref.		EAN
5103407	DS0884	3" 75 mm	5602482008847
5103408	DS0358	4" 100 mm	5602482003583
5103409	DS0359	6" 150 mm	5602482003590
5103410	DS0810	8" 200 mm	5602482008106

SACA ROLAMENTOS (3 PERNOS)

EXTRACTOR UNIVERSAL (3 GARRAS)



Código	Ref.		EAN
5103411	DS0885	3" 75 mm	5602482008854
5103412	DS0360	4" 100 mm	5602482003606
5103413	DS0357	6" 150 mm	5602482003576
5103414	DS1038	8" 200 mm	5602482010383

SUTA

ESQUADRA FALSA



Código	Ref.		EAN
5104910	DS2255 300 mm	10	5602482022553

SUPORTE PARA MARTELO (FIXO)

PORTAMARTILLO (FIJI)



Código	Ref.		EAN
5106211	DS2301 em pele en piel		5602482023017

SUPORTE PARA MARTELO (GIRATÓRIO)

PORTAMARTILLO (GIRATÓRIO)



Código	Ref.		EAN
5106212	DS2254 em pele en piel	10	5602482022546

TORNO DE MESA

TORNILLO BANCO SOBREMESA



Código	Ref.		EAN
5104591	DS1100 2" 50mm		5602482011007
5104592	DS1101 2.1/2" 60 mm		5602482011014

TURQUESA MODELO RUSSO (ISOLADA)

TENAZA RUSA (AISLADA)



Código	Ref.		EAN
5106199	DS1151 9" 225 mm	6	5602482011519

ESCOPRO

CORTAFRÍO



Código	Ref.			EAN
5110442	1063	250 x 16 mm	6	5602482027787
5110443	1064	300 x 16 mm	6	5602482027794
5110444	1065	350 x 16 mm	6	5602482027800

PONTEIRO COM PROTEÇÃO

PONTERO CON PROTECCION



Código	Ref.			EAN
5110454	1103/43	250 x 16 mm	6	5602482027909
5110455	1104/43	300 x 16 mm	6	5602482027916
5110456	1105/43	350 x 16 mm	6	5602482027923

ESCOPRO COM PROTEÇÃO

CORTAFRÍO CON PROTECCION



Código	Ref.			EAN
5110450	1063/43	250 x 16 mm	6	5602482027824
5110451	1064/43	300 x 16 mm	6	5602482027831
5110452	1065/43	350 x 16 mm	6	5602482027848

GRAMPO APERTO RÁPIDO

SARGENTO



Código	Ref.			EAN
5109055	F1002	50 x 100 mm	50	5602482009912
5109056	F1002	50 x 150 mm	50	5602482009929
5109057	F1002	50 x 200 mm	50	5602482009936
5109058	F1002	50 x 250 mm	50	5602482009943
5109059	F1002	80 x 200 mm	30	5602482009950
5109060	F1002	80 x 250 mm	30	5602482009967
5109061	F1002	120 x 300 mm	10	5602482009974
5109062	F1002	120 x 400 mm	10	5602482009981
5109063	F1002	120 x 500 mm	10	5602482009998
5109064	F1002	120 x 600 mm	10	5602482010000
5109065	F1002	120 x 800 mm	6	5602482010017
5109066	F1002	120 x 1000 mm	6	5602482010024
5110549	F1002	120 x 1200 mm	6	5602482010057

PONTEIRO

PONTERO



Código	Ref.			EAN
5110446	1103	250 x 16 mm	6	5602482027862
5110447	1104	300 x 16 mm	6	5602482027879
5110448	1105	350 x 16 mm	6	5602482027886

FAZ TUDO COM RASGO - CABO EM FIBRA

MARTILLO ALBAÑIL - MANGO FIBRA



Código	Ref.		EAN
5117854	85608	600 g	5602482018983

MACETA - CABO EM FIBRA

MACETA - MANGO FIBRA



Código	Ref.		EAN
5114609	84910	1.000 g	5602482047167

MACHADA - CABO EM FIBRA

HACHA - MANGO FIBRA



Código	Ref.		EAN
5109084	74606	600 g	5602482009813

MAÇO BORRACHA - CABO EM FIBRA

MAZA DE GOMA - MANGO FIBRA



Código	Ref.		EAN
5109049	65712	12 onças 360 g	5602482009851
5109050	65716	16 onças 480 g	5602482009868

MACHADO - CABO EM FIBRA

HACHA - MANGO FIBRA



Código	Ref.		EAN
5109052	74616	1,600 g	5602482009820

MAÇO BORRACHA - CABO EM FIBRA

MAZA DE GOMA - MANGO FIBRA



Código	Ref.		EAN
5114607	65812	12 onças 360 g	5602482047143
5114608	65816	16 onças 480 g	5602482047150

MAÇO ANTI RETORNO

MAZA ANTIREBOTE

NOVO



Anti-retorno graças a centenas de bolas de aço que se movem para eliminar o impacto. Revestimento em PU. Anti-chispas.

Antirebote gracias a cientos de bolas de acero que se mueven para eliminar el impacto. Revestimiento de PU. Antichispas.

Código	Ref.			EAN
5118801	64565	Ø 65 mm 1.350 gr.	6	5602482052437
5118802	64575	Ø 75 mm 2 kg.	6	5602482052444

MARTELO BOLA - CABO EM FIBRA

MARTILLO MECÁNICO BOLA - MANGO FIBRA



Código	Ref.			EAN
5109068	24112	12 onças 360 gr.	6	5602482007680
5109069	25116	16 onças 480 gr.	6	5602482007697
5109070	25124	24 onças 720 gr.	6	5602482007703
5109071	25132	32 onças 960 gr.	6	5602482007710
5109072	25148	48 onças 1,450 gr.	6	5602482007727

MARRETA - CABO EM FIBRA

MAZA - MANGO FIBRA



Código	Ref.			EAN
5109080	45208	800 gr.	12	560248009776
5109081	45210	1,000 gr.	12	560248009783
5109082	45212	1,250 gr.	12	560248009790
5109083	44712	1,500 gr.	12	560248009806

MARRETA - CABO EM FIBRA

MAZA - MANGO FIBRA



Código	Ref.			EAN
5117849	45130	3,00 kg	6	560248010208
5117850	45140	4,00 kg	4	560248012233
5117851	45150	5,00 kg	4	560248014183
5117852	451605	6,00 kg	2	560248018969

MARTELO COFRAGEM - CABO EM FIBRA

MARTILLO ENCOFRADOR - MANGO FIBRA



Código	Ref.		EAN
5117853	15370	700 gr.	5602482018976

MARTELO PENA TIPO FRANCÊS - CABO EM FIBRA

MARTILLO EBANISTA - MANGO FIBRA



Código	Ref.		EAN
5109073	35322	22 mm	5602482009752
5109074	35325	25 mm	5602482009769

MARTELO COFRAGEM MEIA UNHA - CABO EM FIBRA

MARTILLO ENCOFRADOR - MANGO FIBRA



Código	Ref.		EAN
5109051	65306	600 gr.	5602482009745

MARTELO S/AMERICANO - CABO EM FIBRA

MARTILLO CARPINTERO - MANGO FIBRA



Código	Ref.		EAN
5109041	15123	23 mm 510 gr.	5602482007123
5109042	15125	25 mm 645 gr.	5602482007130
5109043	15127	27 mm 730 gr.	5602482007147
5109044	15129	29 mm 840 gr.	5602482007666

MARTELO PENA - CABO EM FIBRA

MARTILLO MECÂNICO PEÑA - MANGO FIBRA



Código	Ref.		EAN
5109075	65216	16 mm	5602482007734
5109076	65218	18 mm	5602482008069
5109077	65220	20 mm	5602482008076
5109078	65222	22 mm	5602482009721
5109079	65225	25 mm	5602482009738

PICARETA PÁ/BICO - CABO EM FIBRA

ALCOTANA PALA/PICO - MANGO FIBRA



Código	Ref.		EAN
5109053	85225	2,50 kg	5602482009837
5114469	84615H	2,50 kg OVAL	
5109054	85230	3,00 kg	5602482009844

PICADEIRA TIJOLO CABO FIBRA

ALCOTANA HACHA/PALA MANGO FIBRA

NOVO



Código	Ref.		EAN
5114930	85160	600 gr. 38 cm	5602482050051

PICADEIRA TROLHA CABO FIBRA

ALCOTANA PALA/MARTILLO - MANGO FIBRA

NOVO



Código	Ref.		EAN
5114931	85260	600 gr. 38 cm	5602482050068

PICADEIRA PÁ/BICO CABO FIBRA

ALCOTANA PALA/PICO MANGO FIBRA

NOVO



Código	Ref.		EAN
5118803	85360	600 gr. 38 cm	5602482050075

CABO FIBRA (PARA ENXADAS)

MANGO FIBRA (PARA AZADAS)



Código	Ref.		EAN
5110849	97712H	1.200mm Ø 40mm redondo	5602482029676

CABO FIBRA (PARA MARRETAS)

MANGO FIBRA (PARA MAZAS)



Código	Ref.		EAN
5110743	29-5	280 mm olhal Ø 40x28 oval	5602482029774

CABO FIBRA (PARA MARRETAS)

MANGO FIBRA (PARA MAZAS)



Código	Ref.		EAN
5110747	45130H	900 mm olhal Ø 48x37 oval	5602482029781

CABO FIBRA (PARA MARTELOS)

MANGO FIBRA (PARA MARTILLOS)



Código	Ref.		EAN
5110746	85150H	300 mm olhal Ø 36x26 oval	5602482029798

CABO FIBRA (PARA MARTELOS)

MANGO FIBRA (PARA MARTILLOS)



Código	Ref.		EAN
5110744	15550H	330 mm olhal Ø 30 redondo	5602482029804
5110745	95355H	370 mm olhal Ø 30 redondo	5602482029811

CABO FIBRA (PARA PICARETAS)

MANGO FIBRA (PARA ALCOTANAS)



Código	Ref.		EAN
5110748	85125H	900 mm olhal Ø 47 redondo	5602482029828

FAZ TUDO COM RASGO - CABO MADEIRA

MARTILLO ALBAÑIL - MANGO MADERA



Código	Ref.		EAN
5117843	600 gr.	4	5602482008137

MAÇO BORRACHA PRETA - CABO MADEIRA

MARTILLO GOMA NEGRA - MANGO MADERA



Código	Ref.		EAN
5110112	16 oz. 4860 gr.	6	5602482025585
5110113	24 oz. 720 gr.	6	5602482025592
5110114	32 oz. 960 gr.	6	5602482025608

MACETA - CABO MADEIRA

MACETA - MANGO MADERA



Código	Ref.		EAN
5110108	1.000 gr.	6	5602482025820

MARRETA - CABO EM MADEIRA

MAZA - MANGO MADERA - MANGO MADERA



Código	Ref.		EAN
5109045	40108 800 gr.	12	560248009875
5109046	40110 1,000 gr.	12	560248009882
5109047	40125 1,250 gr.	12	560248009899
5109048	40115 1,500 gr.	12	560248009905

MAÇO BORRACHA BRANCA - CABO MADEIRA

MARTILLO GOMA BLANCA - MANGO MADERA



Código	Ref.		EAN
5110109	12 oz. 360 gr.	6	5602482025554
5110110	16 oz. 480 gr.	6	5602482025561

MARTELO BOLA - CABO MADEIRA

MARTILLO MECÁNICO BOLA - MANGO MADERA



Código	Ref.		EAN
5118766	12 oz. 360 gr.	6	5602482025622
5118767	16 oz. 480 gr.	6	5602482025639
5118768	24 oz. 720 gr.	6	5602482025646
5118769	32 oz. 960 gr.	6	5602482025653
5118770	40 oz. 1.200 gr.	6	5602482025660

MARTELO COFRAGEM - CABO MADEIRA

MARTILLO ENCOFRADOR - MANGO MADERA



Código	Ref.			EAN
5117853	15370	700 gr.	6	5602482018976

MARTELO DE PENNA - CABO MADEIRA

MARTILLO MECÁNICO PEÑA - MANGO MADERA



Código	Ref.			EAN
5110093	16 mm		6	5602482025677
5110094	18 mm		6	5602482025684
5110095	20 mm		6	5602482025691
5110096	22 mm		6	5602482025707
5110097	25 mm		6	5602482025714

MARTELO S/AMERICANO - CABO MADEIRA

MARTILLO CARPINTERO - MANGO MADERA



Código	Ref.			EAN
5110087	18 mm		6	5602482025721
5110088	21 mm		6	5602482025738
5110089	23 mm		6	5602482025745
5110090	25 mm		6	5602482025752
5110091	27 mm		6	5602482025769
5110092	29 mm		6	5602482025776

CHAVE FENDA ISOLADA ELECTRICISTA

DESTORNILLADOR PLANO AISLADO



Código	Ref.			EAN
5114673	3021/11	3,5 x 100 mm	12	5602482027046
5114674	3021/12	5,5 x 125 mm	12	5602482027053
5114675	3021/13	6,5 x 150 mm	12	5602482027060

CHAVE PHILIPS ISOLADA

DESTORNILLADOR PHILIPS AISLADO



Código	Ref.			EAN
5114682	3021/21	0 x 60 mm	12	5602482027145
5114683	3021/22	1 x 80 mm	12	5602482027152
5114684	3021/23	2 x 100 mm	12	5602482027169

CHAVE FENDA LONGA ELECTRICISTA

DESTORNILLADOR PLANO LARGO



Código	Ref.			EAN
5114670	3021/8	3,0 x 200 mm	12	5602482027015
5114671	3021/9	4,0 x 250 mm	12	5602482027022
5114672	3021/10	5,5 x 300 mm	12	5602482027039

CHAVE PHILIPS LONGA

DESTORNILLADOR PHILIPS



Código	Ref.			EAN
5114680	3021/19	1 x 250 mm	12	5602482027121
5114681	3021/20	2 x 300 mm	12	5602482027138

CHAVE FENDA PROFISSIONAL

DESTORNILLADOR PLANO



Código	Ref.			EAN
5114665	3021/1	3,5 x 75 mm	12	5602482026940
5114666	3021/2	5 x 100 mm	12	5602482026957
5114667	3021/3	6 x 125 mm	12	5602482026964
5114668	3021/4	7 x 150 mm	12	5602482026971
5114669	3021/5	8 x 175 mm	12	5602482026988

CHAVE PHILIPS PROFISSIONAL

DESTORNILLADOR PHILIPS



Código	Ref.			EAN
5114676	3021/14	0 x 75 mm	12	5602482027077
5114677	3021/15	1 x 100 mm	12	5602482027084
5114678	3021/16	2 x 125 mm	12	5602482027091
5114679	3021/17	3 x 150 mm	12	5602482027107

CHAVE POZIDRIV PROFISSIONAL

DESTORNILLADOR POZIDRIV



Código	Ref.			EAN
5114685	3021/24	0 x 100 mm	12	5602482027176
5114686	3021/25	1 x 80 mm	12	5602482027183
5114687	3021/26	2 x 100 mm	12	5602482027190
5114688	3021/27	3 x 150 mm	12	5602482027206

CHAVE FENDA PARA ELECTRICISTA

JUEGO DESTORNILLADORES



Composição:
4 chaves fenda para electricista:
 2,5x75 mm | 3,5x100 mm | 5,5x125 mm |
 6,5x150 mm
2 chaves philips:
 PH1x10 mm | PH2x100 mm
1 busca polos de 140 mm

Composicion:
4 destornilladores planos:
 2,5x75 mm | 3,5x100 mm | 5,5x125 mm |
 6,5x150 mm
2 destornilladores philips:
 PH1x80 mm | PH2x100 mm
1 busca polos de 140 mm

Código	Ref.			EAN
5114690	DS2721	7 pcs		5602482027213

CHAVE FENDA PARA PROFISSIONAL

JUEGO DESTORNILLADORES



Composição:
4 chaves fenda:
 2,5x75 mm | 3,5x100 mm | 5,5x125 mm |
 6,5x150 mm
3 chaves philips:
 PH0x75 mm | PH1x100 mm | PH2x125 mm

Composicion:
4 destornilladores planos:
 2,5x75 mm | 3,5x100 mm | 5,5x125 mm |
 6,5x150 mm
3 destornilladores philips:
 PH0x75 mm | PH1x80 mm | PH2x100 mm

Código	Ref.			EAN
5114689	DS2720	7 pcs		5602482027220

CHAVES T/UMBRAKO

LLAVES ALLEN



Medidas: 2,5/ 3/ 4/ 5/ 6/ 8/ 10 mm

Código	Ref.			EAN
5106438	5072F		10	5602482001435

CHAVE TORX

LLAVE TORX



Medidas: T9/ T10/ T15/ T20/ T25/ T27/ T30/ T40

Código	Ref.			EAN
5106450	5083TF	furada p ada	10	5602482020214

FACA ALCATIFA METÁLICA

CUCHILLO DE HOJA FIJA



Código	Ref.		EAN
5109731	SX-75	19 X 61 mm	5602482012585

LÂMINA PARA FACAS ALCATIFA

HOJAS PARA CUCHILLOS



Código	Ref.		EAN
5109732	SX-11N	19 x 61 mm	5602482014435

RASPADOR VIDROS PLÁSTICO

RASCAVIDRIOS PLÁSTICO

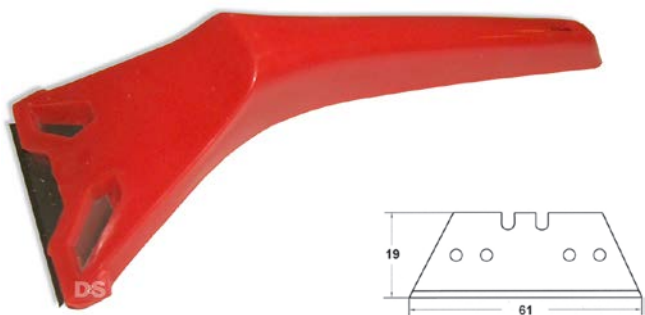

Código	Ref.		EAN
5109733	SX-53-1	19 x 61 mm	5602482012592

X-ATO PLÁSTICO

CÚTER PLÁSTICO



Código	Ref.		EAN
5109738	SX-10	18 x 100 mm	5602482013452

RASPADOR VIDROS METÁLICO

RASCAVIDRIOS METALICO



Código	Ref.		EAN
5110801	SX-802	14 x 100 mm	5602482029910

X-ATO PLÁSTICO

CÚTER PLÁSTICO

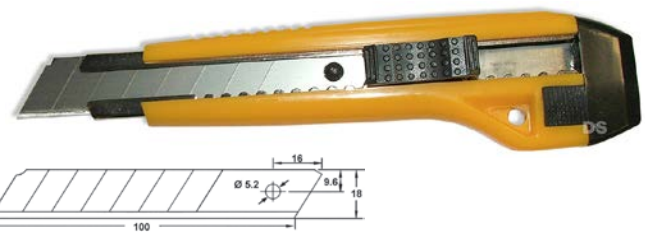

Código	Ref.		EAN
5110803	SX-45	18 x 100 mm	5602482029934

LÂMINAS PARA RASPADORES

HOJAS PARA RASCAVIDRIOS



Código	Ref.		EAN
5110802	SX-802T	14 x 100 mm	5602482029927

X-ATO METÁLICO

CÚTER METÁLICO

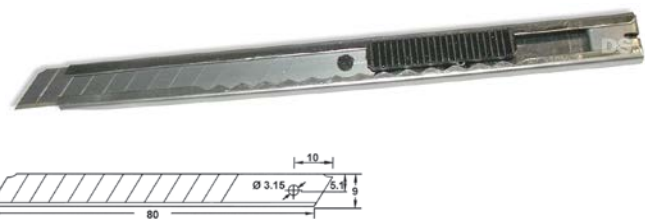

Código	Ref.		EAN
5110804	SX-48A	9 x 80 mm	5602482012912

X-ATO PLÁSTICO/BORRACHHA
CÚTER PLÁSTICO/GOMA

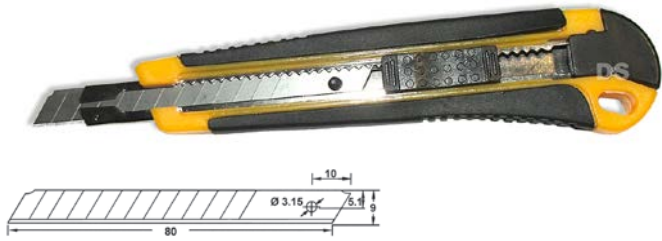

Código	Ref.		EAN
5109725	SX-71-1	9 x 80 mm	5602482028463

X-ATO PLÁSTICO/BORRACHHA
CÚTER PLÁSTICO/GOMA



Código	Ref.		EAN
5109724	SX-1800	18 x 100 mm	5602482021631

X-ATO METÁLICO
CÚTER METÁLICO

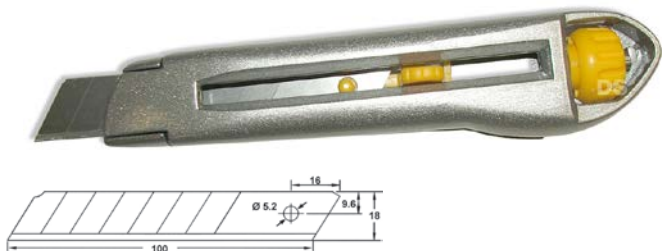

Código	Ref.		EAN
5109729	SX-78	18 x 100 mm	5602482012530

X-ATO PLÁSTICO/BORRACHHA
CÚTER PLÁSTICO/GOMA



Código	Ref.		EAN
5109739	SX-2900	25 x 100 mm	5602482025073

X-ATO METÁLICO
CÚTER METÁLICO

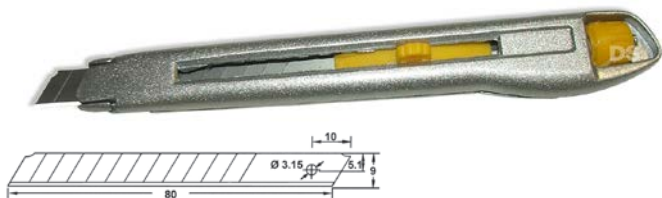

Código	Ref.		EAN
5109730	SX-78-1	9 x 80 mm	5602482012547

LÂMINAS PARA X-ATO
HOJAS PARA CÚTER

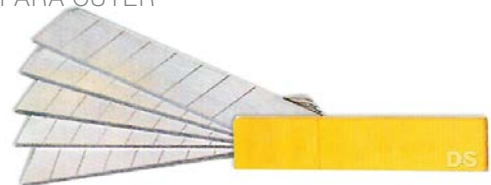

Código	Ref.		EAN
5109736	SX- 9T	9 x 80 mm	5602482013353
5109735	SX-18T	18 x 100 mm	5602482012929
5109737	SX-25T	25 x 100 mm	5602482013421

X-ATO PLÁSTICO/BORRACHHA
CÚTER PLÁSTICO/GOMA



Código	Ref.		EAN
5109723	SX-83	18 x 100 mm	5602482021624

LÂMINAS PARA X-ATO
HOJAS PARA CÚTER



Código	Ref.		EAN
1108129	9AV	9 x 80 mm (10)	5600358470569

X-ATO METÁLICO
CÚTER METÁLICO



Código	Ref.		EAN
1108185	DS4739	18 x 100 mm	5602482047396

X-ATO PLÁSTICO
CÚTER PLÁSTICO

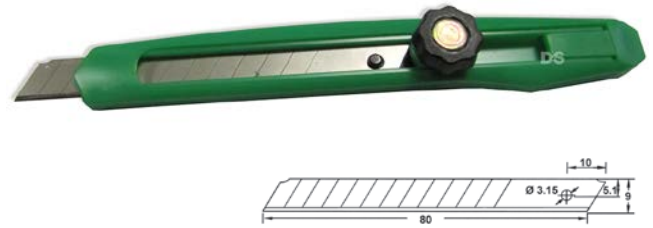

Código	Ref.		EAN
1108123	K-250	9 x 80 mm	8013798000048

X-ATO PLÁSTICO (EXPOSITOR 36 UNID.)
CÚTER PLÁSTICO (EXPOSITOR 36 UNID.)

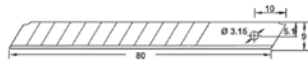

Composição:
4 x-atos K700
8 x-atos K400
12 x-atos K300
12 x-atos K250

Código	Ref.		EAN
1108126	XAT9	9 x 80 mm	5602482046320

X-ATO PLÁSTICO
CÚTER PLÁSTICO

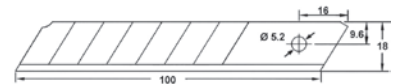

Código	Ref.		EAN
1108125	K-6000	18 x 100 mm	5602482046313

X-ATO PLÁSTICO (EXPOSITOR 24 UNID.)
CÚTER PLÁSTICO (EXPOSITOR 24 UNID.)

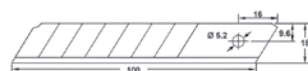

Composição:
12 x-atos K500
12 x-atos K600

Código	Ref.		EAN
1108127	XAT18	18 x 100 mm	5602482046337

PISTOLA PARA ESPUMA

PISTOLA ESPUMA



Código	Ref.		EAN
5112251	GH-PU001B	12	5602482041981

SERINGA MASTIC

PISTOLA SILICONA



Código	Ref.		EAN
5104304	ZP9	40	5602482020504

SERINGA MASTIC

PISTOLA SILICONA



Código	Ref.		EAN
5104305	20022	24	5602482020511

SERINGA MASTIC BLINDADA

PISTOLA SILICONA



* com anilhas metálicas e bicos plásticos

Código	Ref.		EAN
5110805	GH3036A	12	5602482030466

SERINGA MASTIC

PISTOLA SILICONA



Código	Ref.		EAN
5104849	3028	12	5602482021648

SERINGA MASTIC PROFISSIONAL

PISTOLA SILICONA



Código	Ref.		EAN
5110800	GH3042A	12	5602482030459

CATRABUCHA CIRCULAR (ARAME ONDULADO)

CEPILLO CIRCULAR (ALAMBRE ONDULADO)

**ARAME
LATÃO**



Catrabuchas em aço latonado de 0,30 mm.

Aplicações:

• Eliminação de ferrugem, pinturas, desincrustações, rebarbas, etc. • Limpeza de peças de fundição. Recauchutagem. • Tratamento de superfície metálicas, borracha, plásticos, madeira, vidro, etc.

Cepillos de acero latonado de 0,30 mm.

Aplicaciones:

• Eliminación de óxidos, pinturas, cascarrillas, rebabas, etc. • Limpieza de piezas de fundición. Recauchutado. • Tratamiento de superficies metálicas, caucho, plásticos, madera, vidrio, etc.

Código	Ref.		EAN
5116040	DS5202	100 mm 6.500 r.p.m.	5602482052024
5116041	DS5203	125 mm 6.500 r.p.m.	5602482052031
5116042	DS5204	150 mm 6.500 r.p.m.	5602482052048
5116043	DS5205	175 mm 6.500 r.p.m.	5602482052055
5116044	DS5206	200 mm 4.500 r.p.m.	5602482052062

CATRABUCHA T/TAÇA (ARAME ONDULADO)

CEPILLO T/TAZA (ALAMBRE ONDULADO)

**ARAME
LATÃO**



Desenhadas para utilização em máquinas portáteis (rebarbadoras) elétricas ou pneumáticas. Catrabuchas em aço latonado de 0,30 mm.

Aplicações:

• Eliminação de ferrugem, pinturas, e adências • Limpeza de peças de fundição • Tratamento de superfície metálicas, borracha, plásticos, madeira, vidro, etc. • Construção metálica, estaleiros, pedra e betão...

Diseñadas para utilización en máquinas portátiles (amoladoras angulares), eléctricas ou neumáticas. Cepillos acero latonado de 0,30 mm.

Aplicaciones:

• Eliminación de óxidos, pinturas y adherencias en general. • Limpieza de piezas de fundición. • Tratamiento de superficies metálicas, caucho, plásticos, madera, vidrio, etc. • Construcción, astilleros, peidra y hormigón...

Código	Ref.		EAN
5116052	DS5197	M14 x 75 mm 12.500 r.p.m.	5602482051973
5116053	DS5198	M14 x 100 mm 8.500 r.p.m.	5602482051980
5116054	DS5199	M14 x 125 mm 8.500 r.p.m.	5602482051997
5116055	DS5200	M14 x 150 mm 6.000 r.p.m.	5602482052000

CATRABUCHA CÓNICA (ARAME ONDULADO)

CEPILLO CÓNICO (ALAMBRE ONDULADO)

**ARAME
LATÃO**



Especialmente desenhadas para mini rebarbadoras de altas rotações e baixo peso. Em aço latonado de 0,30 mm

Aplicações:

• Para processos de escovagem contínua e frequente (estaleiros, estruturas metálicas, soldadura, manutenção, etc.)

Especialmente diseñados para mini amoladoras de altas revoluciones e baixo peso. De acero latonado de 0,30 mm

Aplicaciones:

• Para procesos de cepillado continuo y frecuentes (astilleros, estructuras metálicas, soldadura, mantenimiento, etc.)

Código	Ref.		EAN
5116048	DS5201	M14 x 100 mm 13.000 r.p.m.	5602482052017

ESCOVA UNIVERSAL SOLDADOR (CABO PLÁSTICO)

CEPILLO MANUAL SOLDADOR (MANGO PLÁSTICO)

**ARAME
INOX**



**ARAME
LATÃO**

Desenho especial que proporciona uma longa duração. Grande densidade de arame para maior pressão de escovagem. Núcleo estreito para facilitar o acesso a ranhuras.

Aplicações:

• Limpeza e eliminação de resíduos de soldadura. • Eliminação de ferrugem, pinturas e aderências em geral. • Adequadas para trabalhos domésticos graças à sua versatilidade e comodidade de uso.

Diseño especial que proporciona larga duración. Gran densidade de alambre para mayor presión de cepillado. Núcleo estrecho para facilitar acceso a ranuras.

Aplicaciones:

• Limpieza y liminación de cascarrillas en soldadura. • Eliminación de óxidos, pinturas y adherencias en general. • Adequado para trabajos domésticos por su versatilidad y comodidad de manejo.

Código	Ref.		EAN
5116056	DS5211	aço inox acero inox	12 5602482052116
5116057	DS5212	aço latonado acero latonado	12 5602482052123

CATRABUCHA PINCEL (ARAME ONDULADO)

CEPILLO BROCHA (ALAMBRE ONDULADO)

ARAME
LATÃO



Catrabuchas para bricolage - Espiga 6 mm

Aplicações:

- Eliminação de ferrugem, pinturas e aderências em varandas, grades, etc.
- Preparação de superfícies a pintar.
- Limpeza de peças metálicas.
- Trabalho de madeiras rústicas.

Cepillos de bricolage - Espiga 6 mm

Aplicaciones:

- Eliminación de óxidos, pinturas y adherencias en verjas, balcones, etc.
- Preparation de superficies para la pintura.
- Pulizo de piezas metálicas
- Labrado de maderas rústicas.

Código	Ref.		EAN
5116049	DS5190 25 mm 4.500 r.p.m.		5602482051904

CATRABUCHA T/TAÇA (ARAME ONDULADO)

CEPILLO T/TAZA (ALAMBRE ONDULADO)

ARAME
LATÃO



Catrabuchas para bricolage - Espiga 6 mm

Aplicações:

- Eliminação de ferrugem, pinturas e aderências em varandas, grades, etc.
- Polimento de peças.
- Preparação de superfícies a pintar.

Cepillos de bricolage - Espiga 6 mm

Aplicaciones:

- Eliminación de óxidos, pinturas y adherencias en verjas, balcones, etc.
- Pulizo de piezas.
- Preparation de superficies para la pintura.

Código	Ref.		EAN
5116050	DS5194 50 mm 4.500 r.p.m.		5602482051942
5116051	DS5195 75 mm 4.500 r.p.m.		5602482051959

CATRABUCHA CIRCULAR (ARAME ONDULADO)

CEPILLO CIRCULAR (ALAMBRE ONDULADO)

ARAME
LATÃO



Catrabuchas para bricolage - Espiga 6 mm

Aplicações:

- Eliminação de ferrugem, pinturas e aderências em varandas, grades, etc.
- Polimento de peças.
- Preparação de superfícies a pintar.

Cepillos de bricolage - Espiga 6 mm

Aplicaciones:

- Eliminación de óxidos, pinturas y adherencias en verjas, balcones, etc.
- Pulido de piezas.
- Preparation de superficies para la pintura.

Código	Ref.		EAN
5116045	DS5191 50 mm 4.500 r.p.m.		5602482051911
5116046	DS5192 75 mm 4.500 r.p.m.		5602482051928
5116047	DS5193 100 mm 4.500 r.p.m.		5602482051935

CATRABUCHA CIRCULAR (ARAME ONDULADO)

CEPILLO CIRCULAR (ALAMBRE ONDULADO)

ARAME
LATÃO



Catrabuchas para bricolage - Ø 13 mm

Aplicações:

- Eliminação de ferrugem, pinturas e aderências em varandas, grades, etc.
- Preparação de superfícies a pintar.
- Limpeza de peças metálicas.
- Trabalho de madeiras rústicas.

Cepillos de bricolage - Ø 13 mm

Aplicaciones:

- Eliminación de óxidos, pinturas y adherencias en verjas, balcones, etc.
- Preparation de superficies para la pintura.
- Pulizo de piezas metálicas
- Labrado de maderas rústicas.

Código	Ref.		EAN
5116039	DS5196 75 mm 4.500 r.p.m.		5602482051966

CATRABUCHA T/TAÇA (ARAME TRANÇADO)

CEPILLO T/TAZA (ALAMBRE TRENZADO)

**ARAME
AÇO**



O sistema de arame trançado confere longa duração e possibilidade de trabalho a elevadas velocidades.

Catrabuchas em aço cinzento de 0,50 mm.

Aplicações:

• Limpeza e eliminação de restos de soldadura, placas metálicas de cofragem, construção metálica, estaleiros, etc.

El sistema de alambre trenzado confere longa duración y posibilidad de trabajo a elevadas velocidades.

Cepillos de acero gris de 0,50 mm.

Aplicaciones:

• Limpieza y eliminación de cascarrillas de soldadura, placas metálicas de encofrado, construcción metálica, astilleros, etc.

Código	Ref.		EAN
5116037	DS5209 M14 x 80 mm 8.500 r.p.m.		5602482052093
5116038	DS5210 M14 x 100 mm 8.500 r.p.m.		5602482052109

CATRABUCHA CÓNICA (ARAME TRANÇADO)

CEPILLO CÓNICO (ALAMBRE TRENZADO)

**ARAME
AÇO**



Especialmente desenhadas para mini rebarbadoras de altas rotações e baixo peso.

Em aço latonado de 0,30 mm

Aplicações:

• Para processos de escovagem contínua e frquente (estaleiros, estruturas metálicas, soldadura, manutenção, etc.)

Especialmente diseñados para mini amoladoras de altas revoluciones e baixo peso.

De acero latonado de 0,30 mm

Aplicaciones:

• Para procesos de cepillado continuo y frecuentes (astilleros, estructuras metálicas, soldadura, mantenimiento, etc.)

Código	Ref.		EAN
5116035	DS5207 M14 x 65 mm 12.500 r.p.m.		5602482052079
5116036	DS5208 M14 x 100 mm 12.500 r.p.m.		5602482052086

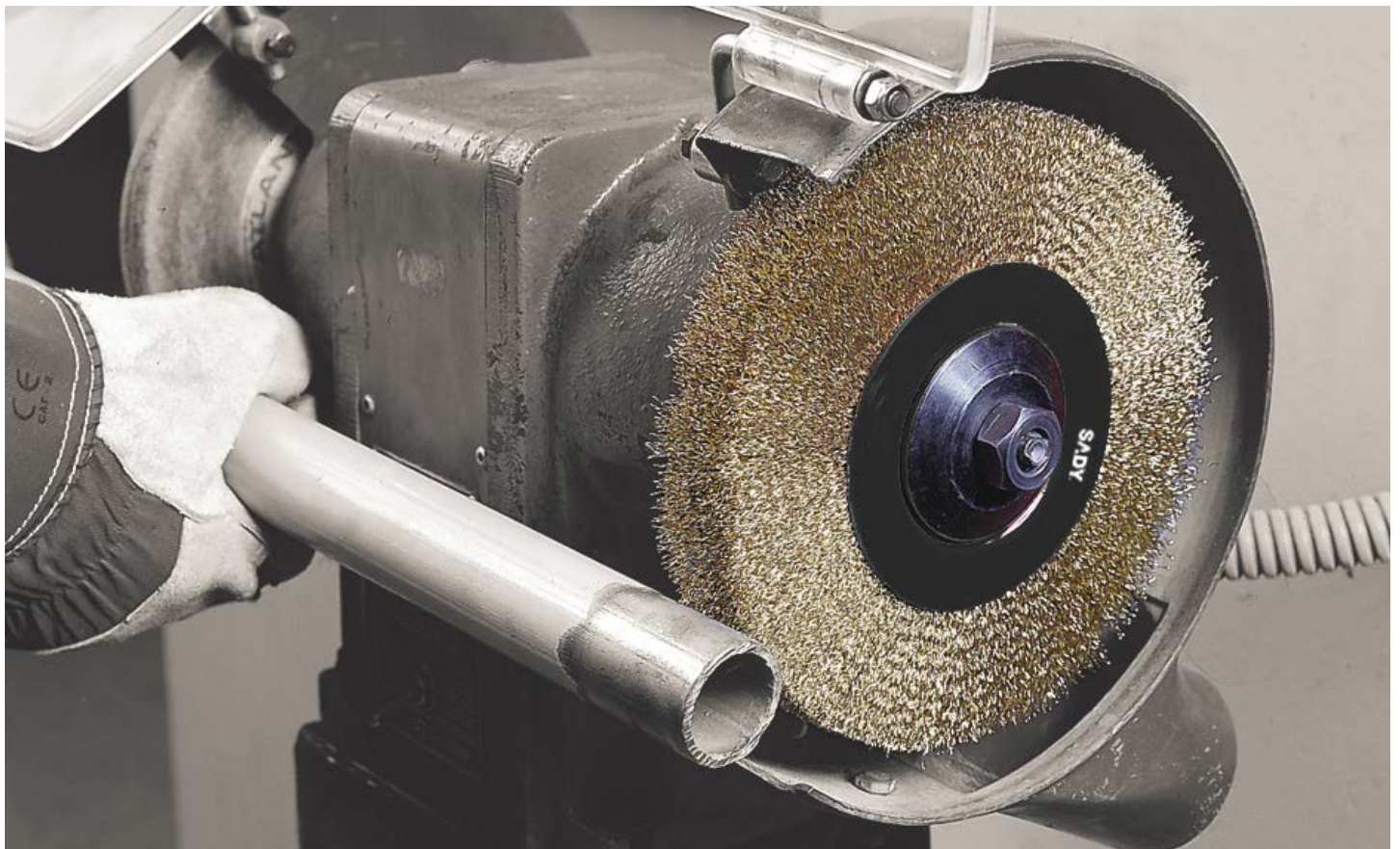

TORNO BANCADA

TORNILLO DE BANCO



Código	Ref.		EAN
5113799	88303	75 mm	5602482045859
5113800	83304	100 mm	5602482045866
5113801	83305	125 mm	5602482045873
5113802	83306	150 mm	5602482045880

TORNO BANCADA AJUSTE RÁPIDO COM MESA

TORNILLO DE BANCO DE AJUSTE RAPIDO

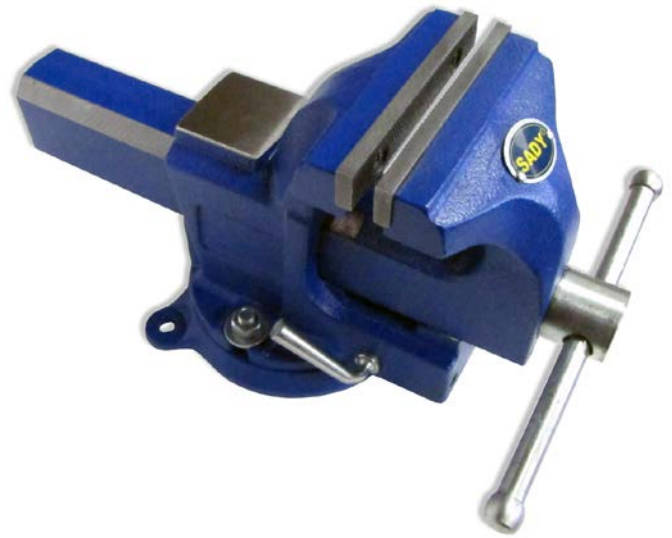

Código	Ref.		EAN
5113807	1404	100 mm	5602482045897
5113808	1405	125 mm	5602482045903

TORNO BANCADA COM MESA

TORNILLO DE BANCO



Código	Ref.		EAN
5113803	83103	75 mm	5602482045811
5113804	83104	100 mm	5602482045828
5113805	83105	125 mm	5602482045835
5113806	83106	150 mm	5602482045842



DISCO CORTE PARA METAL

DISCO CORTE PARA METAL



Discos abrasivos, reforçados com centro elevado. Para usar com rebarbadoras.
Aplicações: Carpintaria, metalurgia, perfis metálicos, tubos...

Código	Ref.		EAN
5101336	115 x 3,2 x 22,2	25	5602482024786
5101341	125 x 3,2 x 22,2	25	5602482024793
5101334	180 x 3,2 x 22,2	25	5602482024809
5101335	230 x 3,2 x 22,2	25	5602482024816

DISCO CORTE INOX

DISCO CORTE INOX



Discos de corte.
Para trabalhos especiais

Código	Ref.		EAN
5101350	115 x 1,0 x 22,2	50	5602482024861
5101351	125 x 1,0 x 22,2	50	5602482024878
5101352	180 x 1,6 x 22,2	25	5602482024885
5100955	230 x 1,9 x 22,2	25	5602482025882

DISCO CORTE PARA METAL - PROFISSIONAL

DISCO CORTE PARA METAL



Discos de corte.
Para trabalhos especiais

Código	Ref.		EAN
5101353	115 x 1,6 x 22,2	50	5602482024892

DISCO PARA REBARBAR METAL

DISCO PARA DESBASTAR METAL



Discos abrasivos reforçados para rebarbar ferro e aço. Para usar com rebarbadoras.
Aplicações: carpintaria, metalurgia em geral, cordões de soldadura, rebarba de fundição..

Código	Ref.		EAN
5101348	115 x 6,4 x 22,2	10	5602482024915
5101349	125 x 6,4 x 22,2	10	5602482024922
5101346	180 x 6,4 x 22,2	10	5602482024939
5101347	230 x 6,4 x 22,2	10	5602482024946

DISCO CORTE PARA PEDRA

DISCO CORTE PARA PIEDRA



Discos de corte para pedra - Discos abrasivos, reforçados para corte de mármore, pedras e materiais de construção. Para usar com rebarbadoras.

Código	Ref.		EAN
5101344	115 x 3,2 x 22,2	25	5602482024823
5101343	230 x 3,2 x 22,2	25	5602482024854

DISCO CORTE PARA PEDRA - PROFISSIONAL

DISCO CORTE PARA PIEDRA



Discos de corte. Para trabalhos especiais

Código	Ref.		EAN
5101354	115 x 1,6 x 22,2	50	5602482024908

DISCO FIBRA DE CARBONO (COM PARAFUSO)

DISCO FIBRA DE CARBONO (CON TORNILLO)



Disco para rebarbadoras. Ideal para remoção de ferrugem, vernizes, acabamento de soldadura... limpa as superfícies sem as danificar

Código	Ref.		EAN
5114585	DS4702 125 x 13 mm		5602482047020

DISCO FIBRA DE CARBONO (PARA REBARBADORAS)

DISCO FIBRA DE CARBONO (PARA REBARBADORAS)



Disco para rebarbadoras. Ideal para remoção de ferrugem, vernizes, acabamento de soldadura... limpa as superfícies sem as danificar

Código	Ref.		EAN
5114586	DS4703 115 x 22,2 mm	5	5602482047037

FALANGE EM BORRACHA

FALANGE DE GOMA



Código	Ref.		EAN
5110130	DPM2678 para rebarbadoras 115 mm	20	5602482026780
5110131	DPM2679 para rebarbadoras 180 mm	15	5602482026797

DISCO DIAMANTADO | CONTÍNUO

DISCO DIAMANTE



Corte de pedras naturais e artificiais, materiais cerâmicos, materiais de construção.

Pastilha: 7 mm

Conforme a norma EN 13236

Corte de piedras naturales y artificiales, ladrillos, materiales de construcción...

Pastilla: 7 mm

Conforme a norma EN 13236

Código	Ref.			EAN
5100964	DS2508	115 x 22,2 mm	100	5602482025080
5110866	DS3051	125 x 22,2 mm	100	5602482030510
5110867	DS3052	180 x 22,2 mm	50	5602482030527
5100975	DS2509	230 x 22,2 mm	25	5602482025097

DISCO DIAMANTADO | SINTER TURBO

DISCO DIAMANTE



Corte de pedras naturais e artificiais, mármore, ladrillos, materiais de construção.

Pastilha: 10 mm

Conforme a norma EN 13236

Corte de piedras naturales y artificiales, ladrillos, hormigón, materiales de construcción...

Pastilla: 10 mm

Conforme a norma EN 13236

Código	Ref.		EAN
5111513	DS4126	115 x 22,2 mm	5602482041264
5111514	DS4127	230 x 22,2 mm	5602482041271

DISCO DIAMANTADO | SEGMENTADO

DISCO DIAMANTE



Corte de pedras naturais e artificiais, betão, tijolo, telha e materiais de construção.

Pastilha: 7 mm

Conforme a norma EN 13236

Corte de piedras naturales y artificiales, ladrillos, hormigón, materiales de construcción...

Pastilla: 7 mm

Conforme a norma EN 13236

Código	Ref.		EAN
5100962	DS2510	115 x 22,2 mm	5602482025103
5110864	DS3049	125 x 22,2 mm	5602482030497
5110865	DS3050	180 x 22,2 mm	5602482030503
5100963	DS2511	230 x 22,2 mm	5602482025110

DISCO DIAMANTADO | SINTER BETON

DISCO DIAMANTE



Corte de pedras naturais e artificiais, betão, tijolo, telha e materiais de construção.

Pastilha: 10 mm

Conforme a norma EN 13236

Corte de piedras naturales y artificiales, ladrillos, hormigón, materiales de construcción...

Pastilla: 10 mm

Conforme a norma EN 13236

Código	Ref.		EAN
5111511	DS4124	115 x 22,2 mm	5602482041240
5111512	DS4125	230 x 22,2 mm	5602482041257

DISCO DIAMANTADO - EXTRA FINO

DISCO DIAMANTE



Corte de pedras naturais e artificiais, azulejos, tijolo, mármore, materiais de construção. Conforme a norma EN 13236

Corte de piedras naturales y artificiales, ladrillos, materiales de construcción... Conforme a norma EN 13236

Código	Ref.			EAN
5110854	DS3014	115 x 1,2 x 22,2 mm	100	5602482030145

DISCO DIAMANTADO - MULTI MASTER

DISCO DIAMANTE - MULTI MASTER



Para corte de perfis e tubos plásticos, madeira (mesmo com pregos), fibra de vidro, betão, metais...

Corte de tubos plásticos, madeira (incluso com clavos), fibra de vidro, hormigón, metales...

Código	Ref.			EAN
5112899	27500115	115 x 5 x 22,2 mm		5602482043077
5112900	27500230	230 x 5 x 22,2 mm		5602482043084

DISCO DIAMANTADO - ELECTRODEPOSITADO

DISCO DIAMANTE



Especiais para cortar mármore.

Especiales para corte de marmol.

Código	Ref.			EAN
5100960	DS2532	115 x 2,2 x 22,2 mm	100	5602482025325
5100961	DS2533	230 x 2,2 x 22,2 mm	25	5602482025332

DISCO DIAMANTADO - MALHA CONTÍNUO

DISCO DIAMANTE



Para corte de grés, material cerâmico, mármore, granito, telha...
Pastilha: largura: 10 mm | altura: 1,2 mm

Para el corte de gres, material cerâmico, mármol, granito, baldosa ...
Pastilla: ancho: 10 mm | altura: 1,2 mm

Código	Ref.			EAN
5114983	30410115	115x1,2x10x22,23 mm		5602482050563
5114984	30410125	125x1,2x10x22,23 mm		5602482050570
5114985	30410230	230x1,2x10x22,23 mm		5602482050587

DISCO CONTÍNUO
DISCO DIAMANTE



Corte de materiais cerâmicos. Para máquina cortar azulejo **DS5278-TSW230** Corte de materiales ceramicos. Para cortadora eléctrica **DS5278-TSW230**

Código	Ref.			EAN
5116090	DS4989	230 x 2,4 x 25,4 mm	25	5602482049895

TAÇA DIAMANTADA SGMMENTADA
MUELA DIAMANTE

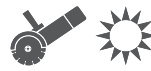

Para aplainar e nivelar superfícies de betão e betão à vista, granito, pedra... Pastilha: largura: 15 mm | altura: 5 mm Para aplainar e igualar superficies de hormigón y hormigón a la vista, granito, piedra... Pastilla: ancho: 15 mm | altura: 5 mm

Código	Ref.			EAN
5114986	31000745	115 x 22,23 mm		5602482050679
	31000705	125 x 22,23 mm		5602482050686
5114987	31000707	180 x 11,23 mm		5602482050693

TAÇA DIAMANTADA
MUELA DIAMANTE



Para aplainar e nivelar superfícies de betão e betão à vista, granito, pedra... Pastilha: largura: 8 mm | altura: 5 mm Para aplainar e igualar superficies de hormigón y hormigón a la vista, granito, piedra... Pastilla: ancho: 8 mm | altura: 5 mm

Código	Ref.			EAN
5112901	31000345	115 x 22,23 mm		5602482043091
5114977	31000305	125 x 22,23 mm		5602482050655
5114978	31000307	180 x 11,23 mm		5602482050662

TAÇA DIAMANTADA TURBO
MUELA DIAMANTE



Para aplainar e nivelar superfícies de betão e betão à vista, granito, pedra... Pastilha: altura: 5 mm Para aplainar e igualar superficies de hormigón y hormigón a la vista, granito, piedra... Pastilla: altura: 5 mm

Código	Ref.			EAN
5114989	31000145	115 x 22,23 mm		5602482050709
5114988	31000105	125 x 22,23 mm		5602482050716
	31010107	180 x 11,23 mm		5602482050723

DISCO DE LAMELAS PARA INOX

DISCO LAMINAS PARA INOX





Tipo Z - Discos com zircónio para aço inox, aços especiais e plásticos. Superfície de contacto plana. Suporte em fibra de nylon

DISCO DE LIXA

DISCO DE LIJA



Código	Ref.		EAN
5101355	grão / grano 40 115 x 22,2	5	5602482024953
5101356	grão / grano 60 115 x 22,2	5	5602482024960
5101357	grão / grano 80 115 x 22,2	5	5602482024977
5100956	grão / grano 100 115 x 22,2	5	5602482025349
5100957	grão / grano 120 115 x 22,2	5	5602482025356

Código	Ref.		EAN
5101362	Ø 115 grão / grano 16	25	5602482030725
5101364	Ø 115 grão / grano 24	25	5602482030541
5101366	Ø 115 grão / grano 36	25	5602482030565
5101367	Ø 115 grão / grano 40	25	5602482030572
5101368	Ø 115 grão / grano 50	25	5602482030589
5101372	Ø 115 grão / grano 60	25	5602482030596
5101373	Ø 115 grão / grano 80	25	5602482030602
5101374	Ø 115 grão / grano 100	25	5602482030619
5101375	Ø 115 grão / grano 120	25	5602482030626
5117992	Ø 125 grão / grano 16	25	5602482037502
5117993	Ø 125 grão / grano 20	25	5602482037519
5117994	Ø 125 grão / grano 24	25	5602482037526
5117996	Ø 125 grão / grano 36	25	5602482037540
5117997	Ø 125 grão / grano 40	25	5602482037557
5117999	Ø 125 grão / grano 60	25	5602482037571
5118000	Ø 125 grão / grano 80	25	5602482037588
5118001	Ø 125 grão / grano 100	25	5602482037595
5118002	Ø 125 grão / grano 120	25	5602482037601
5103694	Ø 180 grão / grano 20	25	5602482041998
5101377	Ø 180 grão / grano 30	25	5602482030640
5101378	Ø 180 grão / grano 36	25	5602482030657
5101379	Ø 180 grão / grano 40	25	5602482030664
5101381	Ø 180 grão / grano 60	25	5602482030688
5101382	Ø 180 grão / grano 80	25	5602482030695
5101383	Ø 180 grão / grano 100	25	5602482030701
5101384	Ø 180 grão / grano 120	25	5602482030718

DISCO DE LAMELAS PARA METAIS

DISCO LAMINAS PARA METALES



Tipo A - Discos em oxido de alumínio regular, para metais ferrosos. Superfície de contacto plana. Suporte em fibra de nylon.

Código	Ref.		EAN
5101358	grão / grano 40 115 x 22,2	5	5602482024984
5101359	grão / grano 60 115 x 22,2	5	5602482024991
5101360	grão / grano 80 115 x 22,2	5	5602482025004
5100958	grão / grano 100 115 x 22,2	5	5602482025868
5100959	grão / grano 120 115 x 22,2	5	5602482025875

DISCO LIXA COM VELCRO

DISCO DE LIJA

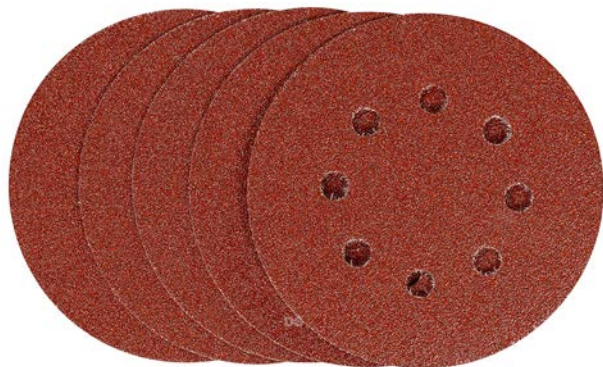

Código	Ref.			EAN
5114639	1919	125 mm grão / grano 60	25	5602482048942
5114638	1919	125 mm grão / grano 80	25	5602482048959
5114636	1919	125 mm grão / grano 100	25	5602482048966
5114637	1919	125 mm grão / grano 120	25	5602482048973

TAÇA ESMERIL

MUELA DE ESMERIL



Características - Produto aglomerado em carburo de silício e óxido de alumínio
Utilização - Desbaste, polimento e acabamentos.
Aplicações - Alto rendimento em mármore e construção civil.

Código	Ref.			EAN
5110120		grão / grano 16 100 x 54 M14	27	5602482026803
5110122		grão / grano 24 100 x 54 M14	27	5602482026827
5110124		grão / grano 36 100 x 54 M14	27	5602482026841
5110125		grão / grano 40 100 x 54 M14	27	5602482026858
5110126		grão / grano 80 100 x 54 M14	27	5602482026865
5110127		grão / grano 60 100 x 54 M14	27	5602482026872
5110128		grão / grano 100 100 x 54 M14	27	5602482026889
5110129		grão / grano 120 100 x 54 M14	27	5602482026896

DISCO LIXA COM VELCRO | LIXADORAS GESSO

DISCO DE LIJA | LIJADORAS GESSO



Código	Ref.			EAN
5114779	DS510	Ø 225 mm Grão 80	25	5602482050297
5114780	DS510	Ø 225 mm Grão 120	25	5602482050303
5114781	DS510	Ø 225 mm Grão 240	25	5602482050310

FALANGE EM BORRACHA

FALANGE DE GOMA



Código	Ref.			EAN
5114888	DPM5134	para rebarbadoras 115 mm		5602482051348

BUSCA POLOS

DESTORNILLADOR BUSCAPOLOS



Código	Ref.		EAN
5116066	DS5275	140 mm	5602482052758

BUSCA POLOS

DESTORNILLADOR BUSCAPOLOS



Código	Ref.		EAN
5116067	DS5276	190 mm	5602482052765

MULTÍMETRO DIGITAL

MULTÍMETRO DIGITAL



- Voltagem AC: 2V/ 20V/ 200V/ 600V
- Voltagem DC: 200mV/ 2V/ 20V/ 200V/ 600V
- Corrente DC: 200µA/ 2000µA/ 20mA/ 200mA/ 2A/ 10A
- Resistência: 200 Ω/ 2kΩ/ 20kΩ/ 200 kΩ/ 2MΩ/ 20MΩ
- Detetor tensão NCV
- Teste de diodo

- Voltage AC: 2V/ 20V/ 200V/ 600V
- Voltage DC: 00mV/ 2V/ 20V/ 200V/ 600V
- Corriente DC: 200µA/ 2000µA/ 20mA/ 200mA/ 2A/ 10A
- Resistencia: 00 Ω/ 2kΩ/ 20kΩ/ 200 kΩ/ 2MΩ/ 20MΩ
- Detetor tensión NCV
- Testigo de diodo

Código	Ref.		EAN
5116069	DS5274		5602482052741

BUSCA PQLOS PARA BATERIAS

DESTORNILLADOR BUSCAPOLOS



Com cabo e pinça

Con cable y pinza

Código	Ref.		EAN
5116068	DS5277	Ø 2 x 100 mm	5602482052772

FITA ISOLAMENTO ELÉTRICO

CINTA AISLANTE



Aplicações: Fita em PVC plastificado, com uma excelente flexibilidade e adesividade a baixas temperaturas.

- Para isolamento de fios e cabos, marcação, agrupamento, reparação.

Características:

- Produto certificado de acordo com DEKRA.
- Protecção segura até **7.000V**

Código	Ref.	20 met. x 19 mm		EAN
5511673	DS5125	amarelo/verde	10	5602482051256
5511674	DS5126	amarelo	10	5602482051263
5511675	DS5127	azul	10	5602482051270
5511676	DS5128	branco	10	5602482051287
5511677	DS5129	castanho	10	5602482051294
5511678	DS5130	cinza mate	10	5602482051300
5511679	DS5131	preto	10	5602482051317
5511680	DS5132	verde	10	5602482051324
5511681	DS5133	vermelho	10	5602482051331

FITA MÉTRICA FIBRA VIDRO

FLEXÓMETRO FIBRA DE VIDRIO

NOVO

FIBRA VIDRO



Caixa aberta de ABS muito resistência. Punho bimatéria e desenho ergonómico.

Caja abierta de ABS muy resistente. Empuñadura bimatéria y diseño ergonómico.

Código	Ref.		EAN
5118784	DS5338-19B	50 met. x 15 mm	5602482053380

FITA MÉTRICA FIBRA VIDRO | EL

FLEXÓMETRO FIBRA DE VIDRIO | EL

NOVO

FIBRA VIDRO



Caixa em ABS revestida em borracha. Fita em fibra de vidro. Manivela de plástico.

Caja de ABS, recubierta de goma. Cinta de fibra de vidrio. Manivela de plástico.

Código	Ref.		EAN
5118785	DS5339-EL	20 met. x 15 mm	5602482053397
5118786	DS5340-EL	30 met. x 15 mm	5602482053403

FITA MÉTRICA FIBRA VIDRO | HY

FLEXÓMETRO FIBRA DE VIDRIO | HY

NOVO

FIBRA VIDRO



Caixa plástica. Fita em fibra de vidro. Manivela metálica.

Caja en plástico. Cinta de fibra de vidrio. Manivela de metal.

Código	Ref.		EAN
5118789	DS5343-HY	10 met. x 13 mm	5602482053434
5118790	DS5344-HY	20 met. x 13 mm	5602482053441
5118791	DS5345-HY	30 met. x 16 mm	5602482053458

FITA MÉTRICA AÇO | GL

FLEXÓMETRO ACERO | GL

NOVO

AÇO



Caixa em ABS revestida em borracha. Fita em aço branco. Manivela de plástico.

Caja de ABS, recubierta de goma. Cinta de acero blanco. Manivela de plástico.

Código	Ref.		EAN
5118787	DS5341-GL	20 met. x 13 mm	5602482053410
5118788	DS5342-GL	30 met. x 13 mm	5602482053427

FITA MÉTRICA BIMATERIA | RX

FLEXÓMETRO BIMATERIA | RX

NOVO



Fita em aço com revestimento em nylon. Caixa em ABS com revestimento em borracha. Botão de bloqueio e recolha automática. Gancho metálico.

Cinta de acero con revestimiento de nylon. Caja de ABS con revestimiento de goma. Botón de bloqueio y retracción automática. Gancho de metal.

Código	Ref.		EAN
5118792	DS5346-RX	3 met. x 16 mm	5602482053465
5118793	DS5347-RX	5 met. x 19 mm	5602482053472
5118794	DS5348-RX	5 met. x 25 mm	5602482053489
5118795	DS5349-RX	8 met. x 25 mm	5602482053496

FITA MÉTRICA | XTS

FLEXÓMETRO | XTS

NOVO



Fita em aço com revestimento em nylon. Caixa em ABS. Botão de bloqueio e recolha automática. Gancho metálico.

Cinta de acero con revestimiento de nylon. Caja de ABS. Botón de bloqueio y retracción automática. Gancho de metal.

Código	Ref.		EAN
5118796	DS5353-XTS	3 met. x 16 mm	5602482053502
5118797	DS5351-XTS	5 met. x 19 mm	5602482053519

FITA MÉTRICA
FLEXÓMETRO



Código	Ref.		EAN
5113810	20 m	20	5602482019874
5113811	30 m	20	5602482019898

ESQUADRO
ESCUADRA

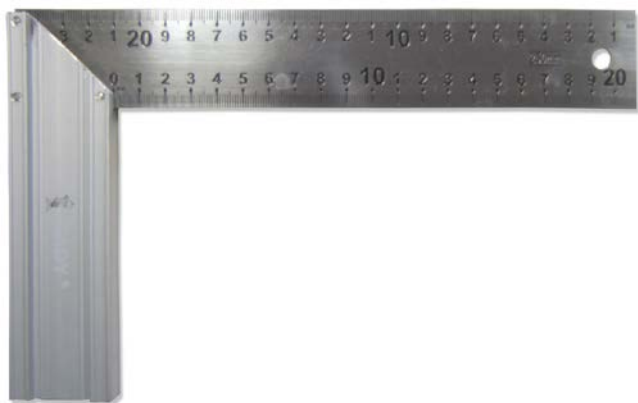

Código	Ref.		EAN
5109705	GWS-25D 250 mm	6	5602482020832
5109706	GWS-30D 300 mm	6	5602482020849
5109707	GWS-40D 400 mm	6	5602482020856
5109708	GWS-50D 500 mm	6	5602482020863

PAQUÍMETRO INOX
CALIBRE PIE DE REY INOX



Código	Ref.		EAN
5104225	81101502 150 mm	10	5602482027244

COMPASSO COM REGULAÇÃO (AÇO)
COMPÁS DE PUNTAS (ACERO)



Código	Ref.		EAN
5106849	7641 150 mm	5	5602482016460
5106850	7641 200 mm	5	5602482016477
5106851	7641 250 mm	5	5602482016484
5106852	7641 300 mm	5	5602482016191

ESCALA GRADUADA (AÇO)
REGLA GRADUADA (ACERO)



Código	Ref.		EAN
5100644	7310 300 x 30 x 1 mm	20	5602482016507
5118188	81.21.102 500 x 30 x 1 mm	20	5602482039261
5118189	81.21.103 1.000 x 30 x 1 mm	20	5602482039278

LÁPIS DE CARPINTEIRO

LÁPIZ DE CARPINTERO



Código	Ref.		EAN
5118045	5518-SS OVAL	 100	5602482003361

NÍVEL RAPID

NIVEL RAPID



Código	Ref.		EAN
5114358	95B 100 cm	 30	5602482006034

SUTA GRADUADA

ESQUADRA GRADUADA



Código	Ref.		EAN
5104791	7610 150 mm	 5	5602482016552

TOPÓMETRO

TOPÓMETRO



NOVO

Características

Diâmetro roda	318 mm
Precisão de trabalho	+/- 1%
Unidade de medida	m e dm
Contador	5 dígitos

Código	Ref.		EAN
5118798	DS5352	 5602482053526	5602482053526

RÉGUA ALUMÍNIO COM NÍVEL

REGLA ALUMINIO CON NIVEL



Código	Medidas	Precisão	EAN
5118520	1,5 m 100 x 18 mm	0,5mm/M=0.029°	5602482039452
5118521	2 m 100 x 18 mm	0,5mm/M=0.029°	5602482039469
5118522	2,5 m 100 x 18 mm	0,5mm/M=0.029°	5602482039476
5118523	3 m 100 x 18 mm	0,5mm/M=0.029°	5602482039483

RÉGUA DE ALUMÍNIO

REGLA DE ALUMINIO



Código	Medidas	EAN
5118136	2 m 100 x 18 mm	5602482039391
5118137	2,5 m 100 x 18 mm	5602482039407
5118138	3 m 100 x 18 mm	5602482039414
5118139	3,5 m 100 x 18 mm	5602482039421
5118140	4 m 100 x 18 mm	5602482039438

CABO MADEIRA

MANGO MADERA



Código	Ref.			EAN
1107857	801	1,20 mt. - ancinhos rastrillos	25	5602482031708
1107971	802	1,30 mt. - ancinhos rastrillos	25	5602482041233
1107854	303	1,20 mt. - enxadas azadas	25	5602482005846
1107867	305	1,30 mt. - enxadas azadas	25	5602482031715
1108133	306	1,40 mt. - enxadas azadas	25	
1107873	702	1,30 mt. - forquilhas horcas	25	5602482030848
1107860	504	1,20 mt. - sachos azadas	25	5602482031753
1107924	505	1,30 mt. - sachos azadas	25	5602482039339

CABO MADEIRA

MANGO MADERA



Código	Ref.			EAN
1107856	401	900 mm - machados hacas	25	5602482031739
1107855	901	900 mm - marretas mazas	25	5602482029279
1107853	201	900 mm - picaretas picos	25	5602482001404

CABO MADEIRA

MANGO MADERA



Código	Ref.			EAN
1107866		240 mm - macetas		5602482031722

CABO MADEIRA

MANGO MADERA



Código	Ref.			EAN
1107881	406	370 mm - machadinhas hacha		5602482030855

CABO MADEIRA PARA CHURRASQUEIRA

MANGO MADERA PARA PARRILA



Código	Ref.			EAN
1108139	160 mm		12	5602482046658
1108140	200 mm			5602482046665

CABO MADEIRA PARA MARTELOS

MANGO MADERA PARA MARTILLOS



Código	Ref.			EAN
1107882	1111	370 mm chanfrado		5602482030862
1107864		Nº 1 320 mm - cónico		5602482032682
1107865		Nº 2 320 mm - cónico		5602482032699
1100750		redondo		5602482000148
1100751		s/americano		5602482001343

CABO MADEIRA PARA FERRAMENTAS

MANGO MADERA PARA HERRAMIENTAS



Código	Ref.			EAN
1100741		Nº 0		5602482032897
1100742		Nº 1		5602482032903
1100743		Nº 2		5602482032910
1100744		Nº 3		5602482032927
1100745		Nº 4		5602482032934
1100746		Nº 5		5602482032941
1100747		Nº 6		5602482032958

CABO MADEIRA PARA LIMAS

MANGO MADERA PARA LIMAS



Código	Ref.			EAN
1101267		Nº 0		5602482031746
1101268		Nº 1		5602482024855
1101269		Nº 2		5602482024762
1101270		Nº 3		5602482002203
1101271		Nº 4		5602482024779
1101272		Nº 5		5602482002258
1101273		Nº 6		5602482002340

CABO MADEIRA ASA PLÁSTICA

MANGO MADERA ASA PLÁSTICA



Código	Ref.			EAN
1107861	613	pás palas	12	5602482032705

CHAVE PARA ATAR ARAME

LLAVE PARA ALAMBRE



Código	Ref.		EAN
1108025	225 mm		5602482040168

FURADOR

PUNZÓN



Código	Ref.		EAN
1108230	940 90 mm x Ø 5 mm		5602482049901

CINGENTO "T"

SARGENTO "T"



Código	Ref.		EAN
1100785	1 m		56024820
1100786	1,25 m		56024820
1100787	1,5 m		56024820
1100788	1,75 m		56024820
1100789	2 m		56024820
1100790	2,25 m		56024820
1100791	2,5 m		56024820

FIO DE PRUMOS

HILO DE PLOMBO



Código	Ref.		EAN
1501023	50 m	12	5602482042384

ELECTRODOS

ELECTRODOS



Código	Ref.		EAN
5100684	2 x 300 mm (5 kg.) 520	25	5602482025042
5113137	2,5 x 350 mm (5 kg.) 260	19	5602482025059
5110613	3,25 x 350 mm (5 kg.) 160	19	5602482025066

FIO PEDREIRO PT 1

HILO NYLON



Código	Ref.		EAN
1501030	250 gramas	4	5602482042711

PRUMO LATÃO ESPECIAL - BICO AÇO

PLOMADA LATÓN - PICO ACERO



Código	Ref.		EAN
1107833	Tipo A		5602482032491
1107834	Tipo B		5602482032507
1107835	Tipo C		5602482032514
1107836	Tipo D		5602482032521

PRUMO LATÃO ESPECIAL - BICO AÇO (COM IMAN)

PLOMADA LATÓN - PICO ACERO (CON IMÁN)



Código	Ref.		EAN
1107868	Tipo A		5602482032538
1107869	Tipo B		5602482032545
1107870	Tipo C		5602482032552

PRUMO LATÃO MACIÇO - TIPO PIÃO

PLOMADA LATÓN CON PLOMO - TIPO PEÓN



Código	Ref.		EAN
1107824	Nº 7		5602482023086
1107825	Nº 8		5602482023093

PRUMO LATÃO - TIPO PIÃO

PLOMADA LATÓN - TIPO PEÓN



Código	Ref.		EAN
1101048	Nº 3		5602482032576
1101049	Nº 4		5602482032583
1101050	Nº 5		5602482015173
1101051	Nº 6		5602482015395
1101052	Nº 7		5602482015180
1101053	Nº 8		5602482032590

PRUMO LATÃO - TIPO PESO

PLOMADA LATÓN - TIPO PESO



Código	Ref.		EAN
1101041	Nº 3		5602482032569
1101042	Nº 4		5602482015197
1101043	Nº 5		5602482009486
1101044	Nº 6		5602482015203
1101045	Nº 7		5602482009493
1101046	Nº 8		5602482015210

TALOCHA PLÁSTICA - BICO

TALOCHA PLÁSTICA - ANGULAR



TALOCHA PLÁSTICA LONGA

TALOCHA PLÁSTICA LARGA



Código	Ref.		EAN
1107501	Nº 1	295 x 160 mm	5604745121324

Código	Ref.		EAN
1107839	Nº 4	445 x 145 mm	5604745121355

TALOCHA PLÁSTICA

TALOCHA PLÁSTICA



TALOCHA PLÁSTICA COM LIXA

TALOCHA PLÁSTICA COM LIJA



Código	Ref.		EAN
1107500	Nº 1	260 x 160 mm	5604745121317
1101062	Nº 2	340 x 220 mm	5604745121331
1107526	Nº 3	415 x 255 mm	5604745121348

Código	Ref.		EAN
1108112	Nº 1	260 x 160 mm	5602482045002
1108113	Nº 2	340 x 220 mm	5602482045019

TALOCHA PLÁSTICA (BRANCA)

TALOCHA PLÁSTICA (BLANCA)



DESEMPENADEIRA PLÁSTICAS

TALOCHA ESTRECHA



Código	Ref.		EAN
1107859	Nº 2	340 x 220 mm	5602482031937

Código	Ref.		EAN
1107516	Nº 1	300 x 30 mm	5604745121515
1107517	Nº 2	360 x 50 mm	5604745121522
1107518	Nº 3	380 x 70 mm	5604745121539

TALOCHA PLÁSTICA COM ESPONJA

TALOCHA PLÁSTICA CON ESPONJA



GAMELA DE PLÁSTICO

CUBETA DE PLÁSTICO



Código	Ref.		EAN
1108116	Nº 1	265 x 160 x 30 mm	5604745121379

Código	Ref.		EAN
1500891	nº 1	420 x 310 x 95 mm	5604745321311

TALOCHA PLÁSTICA BICO COM ESPONJA

TALOCHA PLÁSTICA ANGULAR CON ESPONJA



GAMELA DE PLÁSTICO

CUBETA DE PLÁSTICO



Código	Ref.		EAN
1108117	Nº 1	300 x 160 x 30 mm	5604745121386

Código	Ref.		EAN
1500892	nº 2	495 x 408 x 110 mm	5604745321328

BALDE PLÁSTICO

CUBO DE PLÁSTICO



GAMELA DE PLÁSTICO (35 LITROS)

CUBETA DE PLÁSTICO (35 LITROS)



Código	Ref.		EAN
1500920	10 litros	25	5604745221314
1500923	15 litros	25	5604745221321

Código	Ref.		EAN
1500912	nº 3	630 x 470 x 160 mm	5604745321335

ALICATE CORTE DIAGONAL

ALICATE CORTE DIAGONAL EXTRA FUERTE



Código	Ref.		EAN
5118782	8" 200 mm	6	

ALICATE TELEFONE DIREITO

ALICATE PUNTA RECTA



Código	Ref.		EAN
5118757	8" 200 mm	6	

ALICATE CORTE FRONTAL

ALICATE CORTE FRONTAL



Código	Ref.		EAN
5118755	6" 150 mm	6	

ALICATE UNIVERSAL

ALICATE UNIVERSAL



Código	Ref.		EAN
5118758	7" 180 mm	6	
5118759	8" 200 mm	6	

ALICATE CORTE LATERAL

ALICATE CORTE LATERAL



Código	Ref.		EAN
5118756	6" 150 mm	6	

MACETA

MACETA



Código	Ref.		EAN
5118760	1.000 gr.	6	

MAÇO BORRACHA BRANCA

MARTILLO GOMA BLANCA



Código	Ref.		EAN
5118761	12 oz. 360 gr.	6	
5118762	16 oz. 480 gr.	6	

MARTELO BOLA

MARTILLO MECÁNICO BOLA



Código	Ref.		EAN
5118766	12 oz. 360 g	6	
5118767	16 oz. 480 g	6	
5118768	24 oz. 720 g	6	
5118769	32 oz. 960 g	6	
5118770	40 oz. 1.200 g	6	

MAÇO BORRACHA PRETA

MARTILLO GOMA NEGRA



Código	Ref.		EAN
5118763	16 oz. 480 gr.	6	
5118764	24 oz. 720 gr.	6	

MARTELO COFRAGEM - CABO MADEIRA

MARTILLO ENCOFRADOR - MANGO MADERA



Código	Ref.		EAN
5117853	15370 700 gr.	6	5602482018976

MARRETA COM CABO MADEIRA

MAZA CON MANGO MADERA



Código	Ref.		EAN
5110106	1.250 gr.	6	5602482025806

MARTELO S/AMERICANO

MARTILLO CARPINTERO



Código	Ref.		EAN
5118771	23 mm	6	
5118772	25 mm	6	
5118773	27 mm	6	
5118781	29 mm	6	

DISCO PARA MADEIRA E PVC

DISCO PARA MADERA Y PVC



Discos de corte para serem utilizados em rebarbadoras manuais.
Utilização: Madeira sem pregos ou outros objetos metálicos e PVC.

Discos de corte para utilização en rebarbadoras.
Utilización: Madera sin clavos y otros objetos metálicos y PVC.

Código	Ref.	Diam. x Esp. x Furo		EAN
5112213	56115614	115 x 22,2 x 1,4 mm		5602482042001
5112329	56230616	230 x 22,2 x 1,6 mm		5602482042339

DISCO HSS VAPORIZADO

DISCO HSS VAPORIZADO



Disco para uso em metais

Disco para uso en metales

Código	Ref.		EAN
5109581	262251932	225 x 32 x 1,9 mm / 180T	5602482028487
5103657	262502032	250 x 32 x 2,0 mm / 200T	5602482013186
5109582	262502532	250 x 32 x 2,5 mm / 200T	5602482028494

DISCO PASTILHADO PARA ALUMINIO

DISCO PARA ALUMINIO



Para todo o tipo de metais não ferrosos, tais como alumínio, latão, cobre e chumbo.
Para corte de aluminio, cobre, latón e y plomo como aluminio, latão, cobre e chumbo.

Código	Ref.		EAN
5109583	232503232	250 x 32 x 3,2 mm / 80T	5602482025516
5103662	232333282	300 x 32 x 3,2 mm / 72T	5602482028500

DISCO PASTILHADO PARA MADEIRA

DISCO PARA MADERA



Código	Ref.		EAN
5101195	221403020	140 x 20 x 2,2 mm / 30T	5602482028531
5109585	221604820	160 x 20 x 2,2 mm / 48T	5602482028548
5109586	221844830	184 x 30 x 2,4 mm / 48T	5602482025530
5118780	DS5623-24T	185 x 16 x 2,4 mm / 24T	5602482056237
5114382	221904830	190 x 30 x 2,4 mm / 48T	5602482046672
5103658	56520032	200 x 30 x 2,8 mm / 32T	5602482024212
5109587	222104830	210 x 30 x 2,4 mm / 48T	5602482025547
5101196	222164830	216 x 30 x 2,4 mm / 48T	5602482028470
5109588	222354830	235 x 30 x 2,6 mm / 48T	5602482000971
5103659	56525040	250 x 30 x 2,2 mm / 40T	5602482013070
5103660	56530048	300 x 30 x 3,2 mm / 48T	5602482013391
5105265	56530060	300 x 30 x 3,2 mm / 60T	5602482019058
5104136	56535060	350 x 30 x 3,2 mm / 60T	5602482013100
5118839	DS5621-24T	315 x 30 x 2,0 mm / 24T	5602482056213
5118840	DS5622-48t	315 x 30 x 2,0 mm / 48T	5602482056220

DISCO PASTILHADO PARA ROÇADORAS

DISCO PARA DESBROZADORAS



Discos para cortar ervas daninhas, ramos de árvores... Discos de corte de mala hierba, ramos de arboles...

Código	Ref.	Diam. x Esp. x Furo		EAN
5107579	2425525436	255 x 1,5 x 25,4 mm / 36T		5602482019034
5107580	2425525440	255 x 1,5 x 25,4 mm / 40T		5602482019041

DISCO PASTILHADO PARA ROÇADORAS

DISCO PARA DESBROZADORAS



Discos para cortar ervas daninhas, ramos de árvores... Discos de corte de mala hierba, ramos de arboles...

Código	Ref.	Diam. x Esp. x Furo		EAN
5118661	TF-1111	255 x 2,5 x 25,4 mm / 20T		5602482040274

LÂMINA PARA ROÇADORA

DISCO 2 PALAS PARA DESBROZADORAS



Discos para cortar ervas daninhas, relvados, desbaste de flores e plantas... Discos de corte de mala hierba, césped, desbaste de flores y plantas...

Código	Ref.	Diam. x Esp. x Furo		EAN
5107581	253052542	300 x 3,0 x 25,4 mm / 2T		5602482022836

DISCO PASTILHADO PARA ROÇADORAS

DISCO PARA DESBROZADORAS



Discos para cortar ervas daninhas, ramos de árvores... Discos de corte de mala hierba, ramos de arboles...

Código	Ref.	Diam. x Esp. x Furo		EAN
5118699	27225024	255 x 2,0 x 25,4 mm / 24T		5602482040311
5118700	27225036	255 x 2,0 x 25,4 mm / 36T		5602482040328
5118701	27225040	255 x 2,0 x 25,4 mm / 40T		5602482040335

LÂMINA PARA ROÇADORAS

DISCO 3 PALAS PARA DESBROZADORAS



Discos para cortar ervas daninhas, relvados, desbaste de flores e plantas... Discos de corte de mala hierba, césped, desbaste de flores y plantas...

Código	Ref.	Diam. x Esp. x Furo		EAN
5107582	253052543	300 x 3,0 x 25,4 / 3T		5602482026049

BROCA COFRAGEM HSS

BROCA HSS



Código	Ref.		EAN
5112903	41306000	6 x 400 mm	5602482043114
5112904	41308000	8 x 400 mm	5602482043121
5112905	41308001	8 x 600 mm	5602482043138
5112906	41310000	10 x 400 mm	5602482043145
5112907	41310001	10 x 600 mm	5602482043152
5112908	41312000	12 x 400 mm	5602482043169
5112909	41312001	12 x 600 mm	5602482043176
5112910	41314001	14 x 600 mm	5602482043183
5112911	41316001	16 x 600 mm	5602482043190

BROCA DIAMANTE

BROCA CONSTRUÇÃO



Código	Ref.		EAN
5106472	3 mm	5	5602482031951
5106473	3,5 mm	10	5602482035928
5106474	4 mm	10	5602482014480
5106475	4,5 mm	5	5602482035935
5106476	5 mm	10	5602482014947
5106477	5,5 mm	5	5602482035942
5106478	6 mm	10	5602482018938
5106479	6,5 mm	5	5602482035959
5106480	7 mm	5	5602482019003
5106481	7,5 mm	10	5602482035966
5106482	8 mm	10	5602482019010
5106483	8,5 mm	5	5602482035973
5106484	9 mm	10	5602482031968
5106485	9,5 mm	10	5602482035980
5106486	10 mm	5	5602482019027
5106487	11 mm	10	5602482031975
5106488	12 mm	10	5602482019850
5106489	13 mm	5	5602482020412
5106490	14 mm	10	5602482031982
5106491	15 mm	5	5602482031999
5106492	16 mm	5	5602482032002
5106493	18 mm	5	5602482032019
5106494	20 mm	5	5602482032026
5106495	22 mm	5	5602482032033
5109874	25 mm	2	5602482032040

BROCA COFRAGEM PARA MADEIRA

BROCA PARA MADEIRA



Indicadas para furar ao longo de cavidades em paredes de madeira, de reboco (mesmo com pregos ou objectos metálicos), sem danificar o acabamento exterior.

Código	Ref.		EAN
5109572	8 x 600 mm		5602482002975
5109573	10 x 600 mm		5602482002982
5109574	12 x 600 mm		5602482003224
5109575	14 x 600 mm		5602482003231

LONGAS / LUNGAS

5106496	300 x 6 mm	2	5602482012011
5106497	300 x 8 mm	2	5602482002425
5106498	300 x 10 mm	2	5602482002432
5106499	300 x 12 mm	2	5602482002449
5106500	30 x 14 mm	2	5602482002456
6106501	30 x 16 mm	2	5602482002463
5106502	300 x 18 mm	2	5602482002470
5106503	300 x 20 mm	2	5602482002487
5106504	400 x 6 mm	2	5602482012028
5106505	400 x 8 mm	2	5602482002494
5106506	400 x 10 mm	2	5602482002500
5106507	400 x 12 mm	2	5602482002517
5106508	400 x 14 mm	2	5602482002524
5106509	400 x 16 mm	2	5602482002531
5106510	400 x 18 mm	2	5602482002548
5106511	400 x 20 mm	2	5602482002555

BROCA DIAMANTE - SUPER

BROCA CONSTRUCCIÓN - SUPER

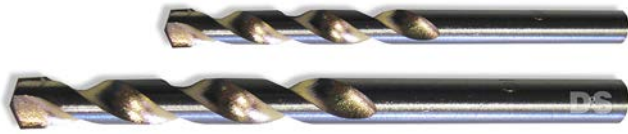

Código	Ref.		EAN
5109473	3 mm	100	5602482020528
5109474	4 mm	100	5602482020535
5104999	5 mm	100	5602482017436
5102466	6 mm	100	5602482017443
5105000	7 mm	100	5602482017450
5102467	8 mm	100	5602482017467
5103422	10 mm	100	5602482017474
5100871	11 mm	50	5602482022669
5102469	12 mm	50	5602482017481
5109478	13 mm	35	5602482020542
5109475	14 mm	35	5602482020559
5109476	15 mm	35	5602482020566
5109477	16 mm	30	5602482020573

BROCA ESCAREADORA PARA MADEIRA

BROCA PARA MADEIRA

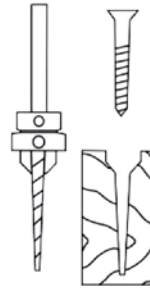

Brocas fabricadas em HSS com 5 arestas de corte, ajustável. Para utilizar com qualquer tipo de parafusos para madeira: cabeça chata, redonda ou oval.

Para ser usadas em madeira, plástico, metais macios...

Fornecida com chave t/humbrako.



Código	Ref.		EAN
5112912	49400030	3 mm	5602482043206
5112913	49400040	4 mm	5602482043213
5112914	49400050	5 mm	5602482043220
5112915	49400060	6 mm	5602482043237

BROCA DIAMANTE

BROCA CONSTRUCCIÓN



Composição:

- 5 peças: 4; 5; 6; 8 e 10 mm
- 8 peças: 3; 4; 5; 6; 7; 8; 9 e 10 mm

Código	Ref.		EAN
5103443	5 brocas		5602482014633
5105309	8 brocas		5602482014640

BROCA HSS

BROCA HSS



Composição:

- 13 peças: 1,5 a 7,5 mm
- 19 peças: 1 a 10 mm (intervalos de 0,5 mm)
- 25 peças: 1 a 13 mm (intervalos de 0,5 mm)

Código	Ref.		EAN
5102462	13 brocas caixa metálica		5602482002753
5100183	19 brocas caixa metálica		5602482002777
5102668	25 brocas caixa metálica		5602482015340

BROCA HSS

BROCA HSS



Código	Ref.		EAN
5106691	0,5 mm	10	5602482035997
5106692	0,75 mm	10	5602482036000
5106693	0,8 mm	10	5602482036017
5105768	1 mm	10	5602482036024
5105769	1,25 mm	10	5602482036031
5105770	1,5 mm	10	5602482027350
5105771	1,75 mm	10	5602482036048
5105772	2 mm	10	5602482027367
5105773	2, 25 mm	10	5602482036055
5105774	2,5 mm	10	5602482027374
5105775	2,75 mm	10	5602482036062
5105776	3 mm	10	5602482027381
5105777	3,25 mm	10	5602482036079
5105778	3,5 mm	10	5602482027398
5105779	3,75 mm	10	5602482027404
5105780	4 mm	10	5602482027411
5105781	4,25 mm	10	5602482027428
5105782	4,5 mm	10	5602482027435
5105783	4,75 mm	10	5602482027442
5105784	5 mm	10	5602482027459
5105785	5,25 mm	10	5602482026086
5105786	5,5 mm	10	5602482027466
5105787	5,75 mm	10	5602482036093
5105788	6 mm	10	5602482027473
5105789	6,25 mm	10	5602482036109
5105790	6,5 mm	10	5602482027480
5105791	6,75 mm	10	5602482036116
5105792	7 mm	10	5602482027497
5105793	7,25 mm	10	5602482036123
5105794	7,5 mm	10	5602482027503
5105795	7,75 mm	10	5602482036130
5105796	8 mm	10	5602482027510
5105797	8,25 mm	10	5602482036147
5105798	8,5 mm	10	5602482027527
5105800	9 mm	10	5602482027534
5105801	9,25 mm	10	5602482036154
5105802	9,5 mm	10	5602482027541
5105804	10 mm	10	5602482027558
5105805	10,5 mm	10	5602482036161
5105806	11 mm	10	5602482027565
5105807	11,5 mm	10	5602482027572
5105808	12 mm	5	5602482027589
5105809	12,5 mm	5	5602482036178
5105810	13 mm	5	5602482027596
5105811	13,5 mm	5	5602482036185
5105812	14 mm	5	5602482036192

BROCA HSS COM ENCABADOURO

BROCA HSS VÁSTAGO REDUCIDO

Código	Ref.		EAN
5105813	14,5 mm	5	5602482036208
5105814	15 mm	5	5602482036215
5105815	15,5 mm	5	5602482036222
5105816	16 mm	5	5602482036239
5105825	16,5 mm	4	5602482036246
5105817	17 mm	4	5602482036253
5105818	17,5 mm	5	5602482036260
5105819	18 mm	4	5602482036277
5105820	18,5 mm	5	5602482036284
5105821	19 mm	4	5602482036291
5105822	19,5 mm	5	5602482036307
5105823	20 mm	4	5602482036314

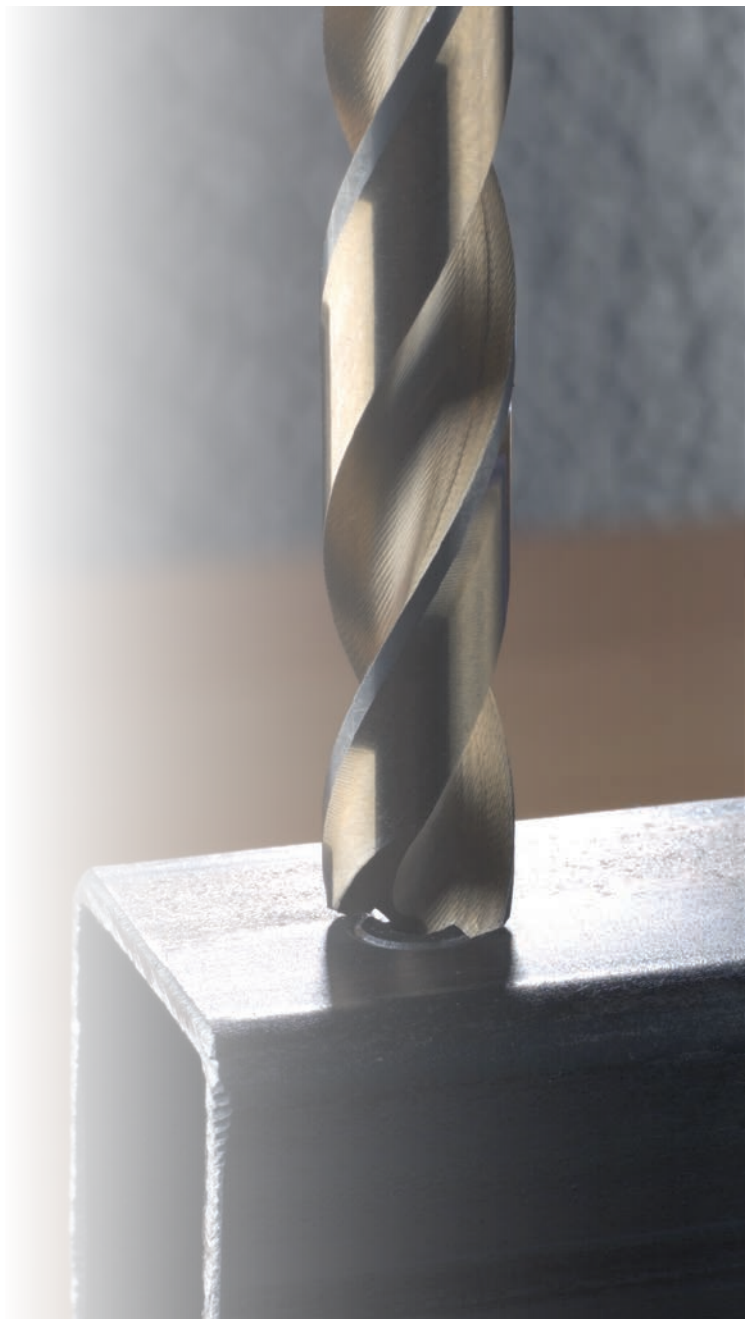

BROCA HSS COBALTO (8%)

BROCA HSS COBALTO (8%)



Código	Ref.		EAN
5108872	1 mm	10	5602482019355
5105573	1,25 mm	10	5602482019362
5108874	1,5 mm	10	5602482019379
5108875	1,75 mm	10	5602482019386
5108876	2, mm	10	5602482019393
5108877	2,25 mm	10	5602482019409
5108878	2,5 mm	10	5602482019416
5108879	2,75 mm	10	5602482019423
5108880	3 mm	10	5602482019430
5108881	3,25 mm	10	5602482019447
5108882	3,5 mm	10	5602482019454
5108883	3,75 mm	10	5602482019461
5108884	4 mm	10	5602482019478
5108885	4,25 mm	10	5602482019485
5108886	4,5 mm	10	5602482019492
5108887	4,75 mm	10	5602482019508
5108888	5 mm	10	5602482019515
5108889	5,25 mm	10	5602482019522
5108890	5,5 mm	10	5602482019535
5108891	5,75 mm	10	5602482019546
5108892	6 mm	10	5602482019553
5108893	6,25 mm	10	5602482019560
5108894	6,5 mm	10	5602482019577
5108895	7 mm	10	5602482019584
5108896	7,5 mm	10	5602482019591
5108897	8 mm	10	5602482019607
5108898	8,5 mm	5	5602482019614
5108899	9 mm	5	5602482019651
5108900	9,5 mm	5	5602482019638
5108901	10 mm	5	5602482019645
5108902	10,5 mm	5	5602482019652
5108903	11 mm	5	5602482019669
5108905	11,5 mm	5	5602482019676
5108905	12 mm	5	5602482019683
5108906	12,5 mm	5	5602482019690
5108907	13 mm	5	5602482019706

BROCAS HSS COBALTO (8%)

Código	Quantidade	Características	Cód. EAN
5108857	170 peças	Caixa metálica	5602482013582

BROCA HSS RETIFICADA

BROCA HSS RETIFICADA



Composição:

- 19 peças: 1 a 10 mm (intervalos de 0,5 mm)
- 25 peças: 1 a 13 mm (intervalos de 0,5 mm)

Código	Ref.		EAN
5106166	19 brocas caixa metálica		5602482015333
5108855	25 brocas caixa metálica		5602482014244

BROCA HSS COBALTO (8%)

BROCA HSS COBALTO (8%)



Composição:

- 1 a 8 mm: 10 brocas cada medida
- 8,5 a 10 mm: 5 brocas cada medida

Código	Ref.		EAN
5108857	170 brocas caixa metálica		5602482013582

BROCA HSS RETIFICADA

BROCA HSS RETIFICADA



Código	Ref.		EAN
5106133	1 mm	10	5602482036321
5108111	1,25 mm	10	5602482036338
5106134	1,5 mm	10	5602482036345
5108112	1,75 mm	10	5602482036352
5106135	2 mm	10	5602482036369
5106136	2,25 mm	10	5602482036376
5106137	2,5 mm	10	5602482036383
5106138	2,75 mm	10	5602482036390
5106139	3 mm	10	5602482036406
5106140	3,25 mm	10	5602482036413
5106141	3,5 mm	10	5602482036420
5106142	3,75 mm	10	5602482036437
5106143	4 mm	10	5602482036444
5106144	4,25 mm	10	5602482036451
5106145	4,5 mm	10	5602482036468
5106146	4,75 mm	10	5602482036475
5106147	5 mm	10	5602482036482
5106148	5,25 mm	10	5602482036499
5106149	5,5 mm	10	5602482036505
5106150	5,75 mm	10	5602482036512
5106151	6 mm	10	5602482036529
5108113	6,25 mm	10	5602482036536
5106152	6,5 mm	10	5602482036543
5106153	7 mm	10	5602482036550
5106154	7,5 mm	10	5602482036567
5106155	8 mm	10	5602482036574
5106156	8,5 mm	10	5602482036581
5106157	9 mm	10	5602482036598
5106158	9,5 mm	10	5602482036604
5106159	10 mm	10	5602482036611
5106160	10,5 mm	10	5602482036628
5106161	11 mm	10	5602482036635
5106162	11,5 mm	10	5602482036642
5106163	12 mm	5	5602482036659
5106164	12,5 mm	5	5602482036666
5106165	13 mm	5	5602482036673

BROCA HSS RETIFICADA

BROCA HSS RETIFICADA



Código	Ref.		EAN
5108858	13,5 mm	5	5602482036680
5108859	14 mm	5	5602482036697
5108860	14,5 mm	5	5602482036703
5108861	15 mm	5	5602482036710
5108862	15,5 mm	5	5602482036727
5108863	16 mm	5	5602482036734
5108864	16,5 mm	4	5602482036741
5108865	17 mm	4	5602482036758
5108866	17,5 mm	4	5602482036765
5108867	18 mm	4	5602482036772
5108868	18,5 mm	4	5602482036789
5108869	19 mm	4	5602482036796
5108870	19,5 mm	4	5602482036802
5108871	20 mm	4	5602482036819

BROCA HSS RETIFICADA

BROCA HSS RETIFICADA



Composição:

- 1 a 8 mm: 10 brocas cada medida
- 8,5 a 10 mm: 5 brocas cada medida

Código	Ref.		EAN
5108856	170 brocas caixa metálica		5602482013575

BROCA PARA PEDRA S.D.S.

BROCA PARA PIEDRA S.D.S.:



Código	Ref.		EAN
5106512	4 x 100 mm		5602482017252
5106513	5 x 110 mm		5602482017269
5109472	5 x 160 mm		5602482015623
5106694	5,5 x 110 mm		5602482017498
5106695	5,5 x 160 mm		5602482017504
5106514	6 x 110 mm		5602482006041
5106515	6 x 160 mm		5602482005877
5106696	6 x 210 mm		5602482017511
5106697	6,5 x 110 mm		5602482017528
5106698	6,5 x 160 mm		5602482017535
5106516	7 x 110 mm		5602482017276
5106517	7 x 160 mm		5602482017283
5106518	8 x 110 mm		5602482005884
5106519	8 x 160 mm		5602482006003
5106520	8 x 210 mm		5602482017290
5106521	10x 110 mm		5602482017306
5106522	10 x 160 mm		5602482006010
5106523	10 x 210 mm		5602482006805
5106524	10 x 260 mm		5602482009639
5106525	10 x 410 mm		5602482017313
5106526	12 x 160 mm		5602482006027
5106527	12 x 210 mm		5602482009646
5106528	12 x 260 mm		5602482006881
5106529	12 x 410 mm		5602482017320
5106530	14 x 160 mm		5602482006812
5106531	14 x 210 mm		5602482009653
5106532	14 x 260 mm		5602482009660
5106533	14 x 410 mm		5602482017337
5106534	15 x 160 mm		5602482017344
5106700	15 x 210 mm		5602482017351
5100872	15 x 410 mm		5602482022676
5106535	16 x 210 mm		5602482006829
5106536	16 x 260 mm		5602482009677
5106536	16 x 410 mm		5602482017368
5106538	18 x 210 mm		5602482009684
5106539	18 x 260 mm		5602482009691
5106540	18 x 410 mm		5602482017375
5106541	20 x 210 mm		5602482009707
5106542	20 x 260 mm		5602482006836
5106543	20 x 410 mm		5602482017382
5106544	22 x 260 mm		5602482017399
5106545	22 x 410 mm		5602482017405
5106701	25 x 260 mm		5602482017412
5106546	25 x 410 mm		5602482017429

BROCA PARA MADEIRA

BROCA PARA MADERA



Código	Ref.		EAN
5109424	3 mm		560248202
5109425	4 mm		560248202
5103398	5 mm		560248202
5103399	6 mm		560248202
5103400	7 mm		560248202
5103401	8 mm		560248202
5103403	10 mm		560248202
5103404	12 mm		560248202
5103405	14 mm		560248202
5103406	16 mm		560248202

BROCA PARA MADEIRA

BROCA PARA MADERA



Composição:

• 8 peças: 3; 4; 5; 6; 7; 8; 9 e 10 mm

Código	Ref.		EAN
5102464	8 peças caixa plástica		5602482002869



Diógenes & Santos, S.A.

**Rua Albino Moreira, 360
4485-767 Vilar VCD - PORTUGAL**

**Tel.: 226 076 310
email: geral@diosan.com**

www.sady.pt